

IW5011



Inductive sensor

IW-3005-APOG/ 6m

Article no longer available - archive entry

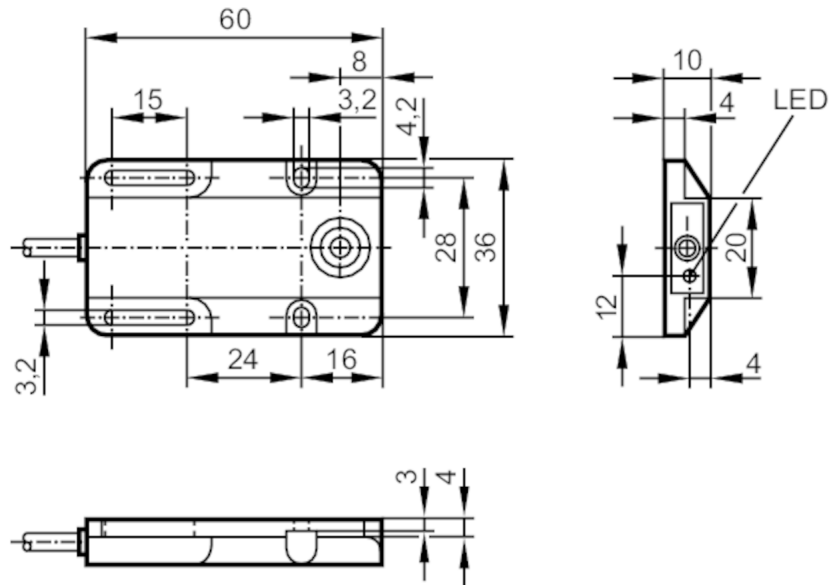

Product characteristics

Electrical design		PNP
Output function		normally closed
Sensing range	[mm]	5
Housing		rectangular
Dimensions	[mm]	60 x 36 x 10

Electrical data

Operating voltage	[V]	10...36 DC
Current consumption	[mA]	15; (24 V)
Protection class		II
Reverse polarity protection		no

Outputs

Electrical design		PNP
Output function		normally closed
Max. voltage drop switching output DC	[V]	1
Permanent current rating of switching output DC	[mA]	250
Switching frequency DC	[Hz]	200
Short-circuit protection		no
Overload protection		no

IW5011



Inductive sensor

IW-3005-APOG/ 6m

Detection zone		
Sensing range	[mm]	5
Real sensing range Sr	[mm]	5 ± 10 %
Operating distance	[mm]	0...4.05
Accuracy / deviations		
Correction factor		steel: 1 / stainless steel: 0.7 / brass: 0.4 / aluminium: 0.3 / copper: 0.2
Hysteresis	[% of Sr]	1...15
Switch point drift	[% of Sr]	-10...10
Operating conditions		
Ambient temperature	[°C]	-25...80
Protection		IP 67
Tests / approvals		
EMC	EN 60947-5-2	class B
	EN 55011	
Mechanical data		
Housing		rectangular
Mounting		flush mountable
Dimensions	[mm]	60 x 36 x 10
Materials		PBT
Displays / operating elements		
Display	switching status	1 x LED, yellow
Remarks		
Pack quantity		1 pcs.

IW5011



Inductive sensor

IW-3005-APOG/ 6m

Electrical connection

Cable: 6 m, PVC; 3 x 0.14 mm²

Connection

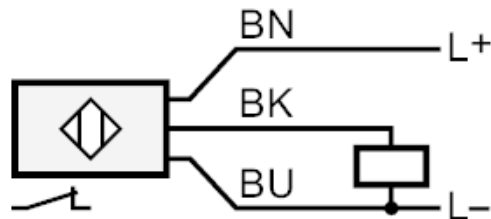

Core colours :

BN = brown
BU = blue
BK = black