

ID5006



Inductive sensor

ID-3050-ANOG/ 6m

Article no longer available - archive entry

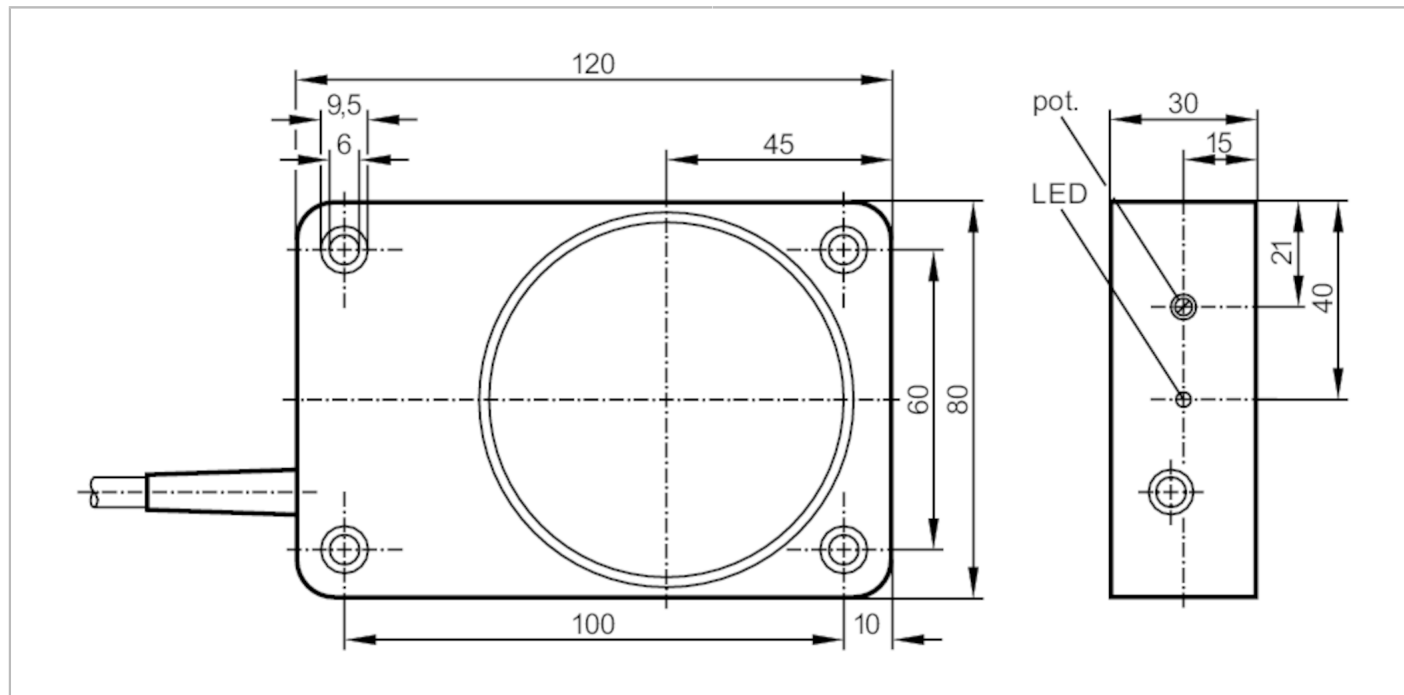

Product characteristics

Electrical design		NPN
Output function		normally open
Sensing range	[mm]	50
Housing		rectangular
Dimensions	[mm]	120 x 80 x 30

Electrical data

Operating voltage	[V]	10...30 DC
Current consumption	[mA]	7; (24 V)
Reverse polarity protection		no

Outputs

Electrical design		NPN
Output function		normally open
Max. voltage drop switching output DC	[V]	1
Permanent current rating of switching output DC	[mA]	200
Switching frequency DC	[Hz]	30
Short-circuit protection		no
Overload protection		no

ID5006



Inductive sensor

ID-3050-ANOG/ 6m

Detection zone		
Sensing range	[mm]	50
Sensing range adjustable		yes
Factory setting sensing range	[mm]	50
Real sensing range Sr	[mm]	50 ± 10 %
Operating distance	[mm]	0...40.5
Accuracy / deviations		
Correction factor		steel: 1 / stainless steel: 0.7 / brass: 0.4 / aluminium: 0.3 / copper: 0.2
Hysteresis	[% of Sr]	1...15
Switch point drift	[% of Sr]	-10...10
Operating conditions		
Ambient temperature	[°C]	-10...50
Protection		IP 65
Tests / approvals		
EMC	EN 60947-5-2	
	EN 55011	class B
Mechanical data		
Housing		rectangular
Mounting		non-flush mountable
Dimensions	[mm]	120 x 80 x 30
Materials		PPE modified
Displays / operating elements		
Display	switching status	1 x LED, yellow
Accessories		
Items supplied		screwdriver: 1
Remarks		
Pack quantity		1 pcs.

ID5006



Inductive sensor

ID-3050-ANOG/ 6m

Electrical connection

Cable: 6 m, PVC; 3 x 0.5 mm²

Connection



Core colours :

BN = brown
BU = blue
BK = black