

RV6031



Incremental encoder with solid shaft

RV-1750-I24/L2

Article no longer available - archive entry

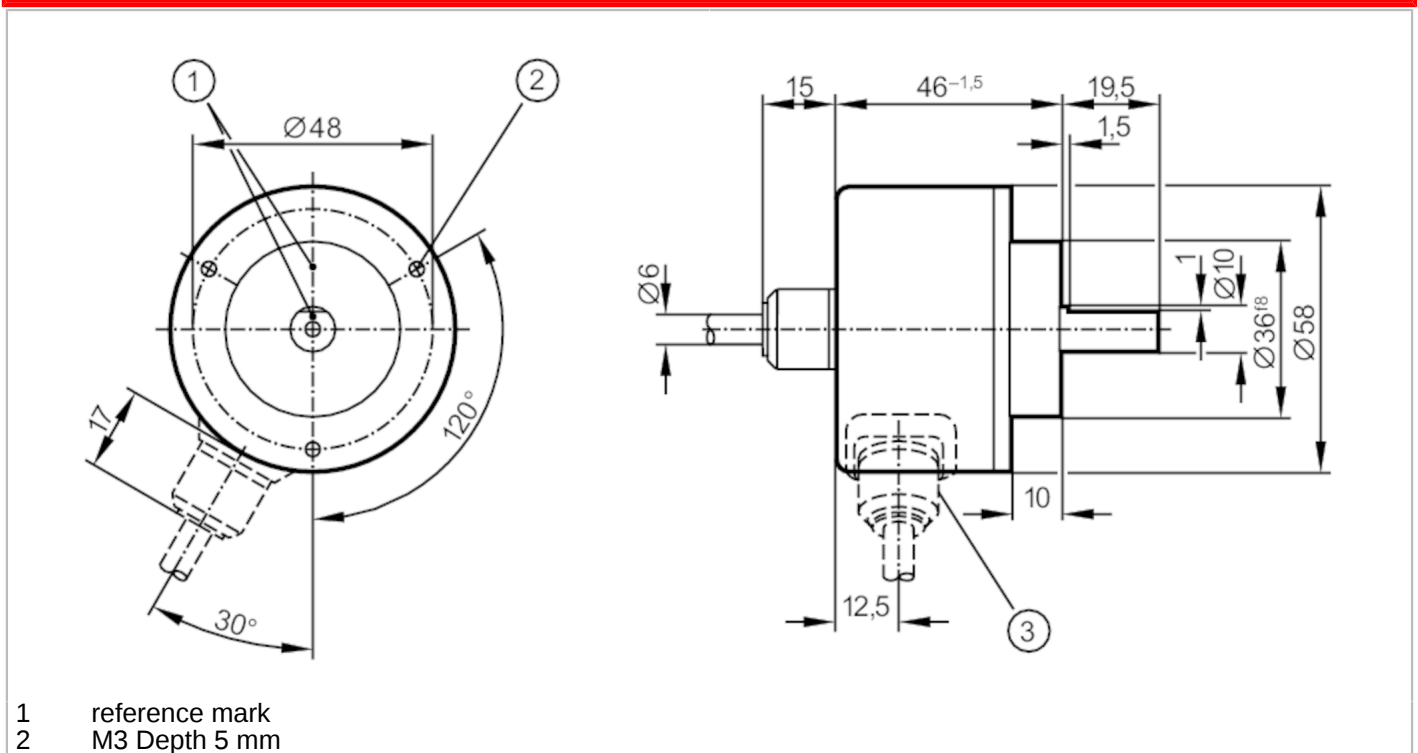

Product characteristics	
Resolution	1750 resolution
Shaft design	solid shaft
Shaft diameter [mm]	10
Electrical data	
Operating voltage [V]	10...30 DC
Current consumption [mA]	150
Outputs	
Electrical design	HTL
Max. current load per output [mA]	50
Switching frequency [kHz]	300
Type of short-circuit protection	< 60 s
Phase difference A and B [°]	90
Measuring/setting range	
Resolution	1750 resolution
Operating conditions	
Ambient temperature [°C]	-30...85
Note on ambient temperature	for firmly laid cable: -30 °C
Storage temperature [°C]	-30...100
Max. relative air humidity [%]	98
Protection	IP 64

RV6031



Incremental encoder with solid shaft

RV-1750-I24/L2

Tests / approvals		
Shock resistance		100 g (6 ms)
Vibration resistance		10 g (55...2000 Hz)
Mechanical data		
Dimensions [mm]		Ø 58 / L = 46
Materials		aluminium
Max. revolution, mechanical [U/min]		12000
Max. starting torque [Nm]		1
Reference temperature torque [°C]		20
Shaft design		solid shaft
Shaft diameter [mm]		10
Shaft material		steel (1.4104)
Max. shaft load axial (at the shaft end) [N]		10
Max. shaft load radial (at the shaft end) [N]		20

Electrical connection

Cable: 2 m, PUR; axial

brown	A
green	A inverted
grey	B
pink	B inverted
red	0 index
black	0 index inverted
blue	L+ sensor
white	0V sensor
brown/green	L+ (Up)
white/green	0V (Un)
lilac	failure inverted
screen	housing

Diagrams and graphs

Pulse diagram	<p>Output A Output B 0 index</p>
---------------	--

Article no longer available - archive entry