

IF0019



Inductive sensor

IF-2004-BBOW/10M

Article no longer available - archive entry

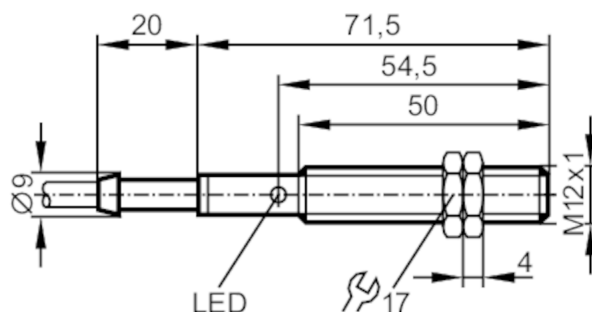

Product characteristics

Output function		normally closed
Sensing range	[mm]	4
Housing		threaded type
Dimensions	[mm]	M12 x 1 / L = 71.5

Electrical data

Frequency AC	[Hz]	47...63
Operating voltage	[V]	20...250 AC
Protection class		II
Reverse polarity protection		no

Outputs

Output function		normally closed
Max. voltage drop switching output AC	[V]	8.5
Minimum load current	[mA]	8
Max. leakage current	[mA]	2
Permanent current rating of switching output AC	[mA]	200; (250 (...50 °C))
Short-time current rating of switching output	[mA]	900; (20 ms / 0,5 Hz)
Switching frequency AC	[Hz]	25
Short-circuit proof		no
Overload protection		no

Detection zone

Sensing range	[mm]	4
Real sensing range Sr	[mm]	4 ± 10 %
Operating distance	[mm]	0...3.25

Accuracy / deviations

Correction factor		steel: 1 / stainless steel: 0.7 / brass: 0.4 / aluminium: 0.3 / copper: 0.2
Hysteresis	[% of Sr]	1...15
Switch point drift	[% of Sr]	-10...10

IF0019



Inductive sensor

IF-2004-BBOW/10M

Operating conditions		
Ambient temperature	[°C]	-25...80
Protection		IP 67
Tests / approvals		
EMC		EN 60947-5-2
MTTF	[years]	932
Mechanical data		
Housing		threaded type
Mounting		non-flush mountable
Dimensions	[mm]	M12 x 1 / L = 71.5
Thread designation		M12 x 1
Materials		PBT
Displays / operating elements		
Display	switching status	1 x LED, yellow
Electrical connection		
Required protection		miniature fuse to IEC60127-2 sheet 1; ≤ 2 A; fast acting
Accessories		
Accessories (supplied)		lock nuts: 2
Remarks		
Remarks		Recommendation: Check the safe functioning of the unit after a short circuit.
Pack quantity		1 pcs.

Electrical connection
Cable: 10 m, PVC; 2 x 0.5 mm²

Connection

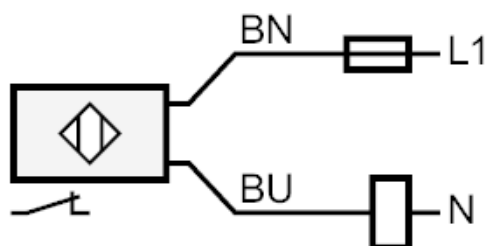

Note miniature fuse to IEC60127-2 sheet 1 ≤ 2 A fast acting

Core colours :

BN = brown
BU = blue

Article no longer available - archive entry