

E37720

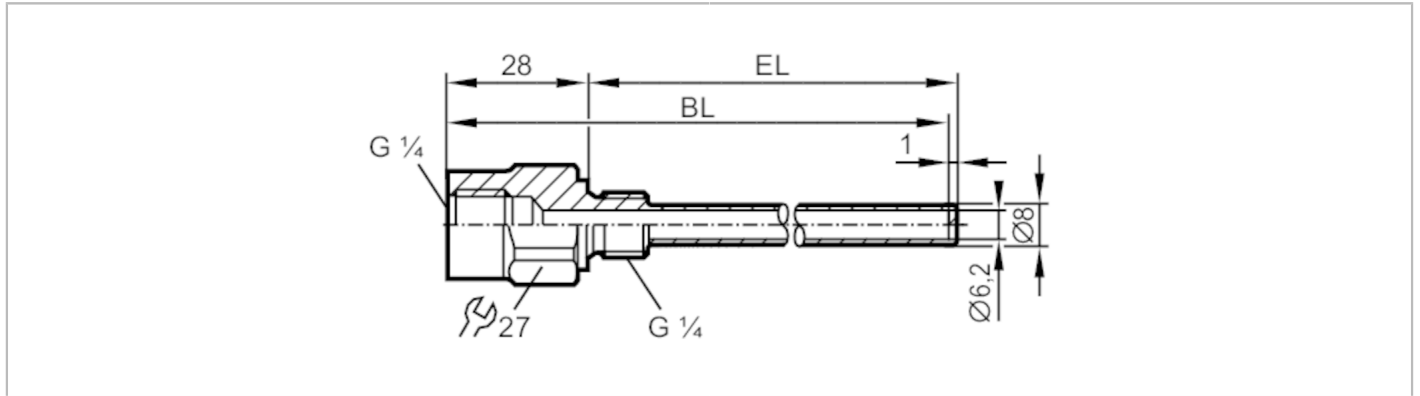

Thermowell for temperature sensors

THERMOWELL, D6/ G1/4 /L=150



Application	
Design	for temperature sensors EL = 150 mm
Pressure rating [bar]	100
Note on pressure rating	< 250 °C
Mechanical data	
Weight [g]	104.3
Materials	stainless steel (1.4571/316Ti)
Sensor connection	G 1/4 Ø 6 mm
Process connection	G 1/4
Installation length EL [mm]	124
Bore length BL [mm]	150
Remarks	
Pack quantity	1 pcs.