

RO1328



Incremental encoder with hollow shaft

RO-1024-I05/N11

Article no longer available - archive entry

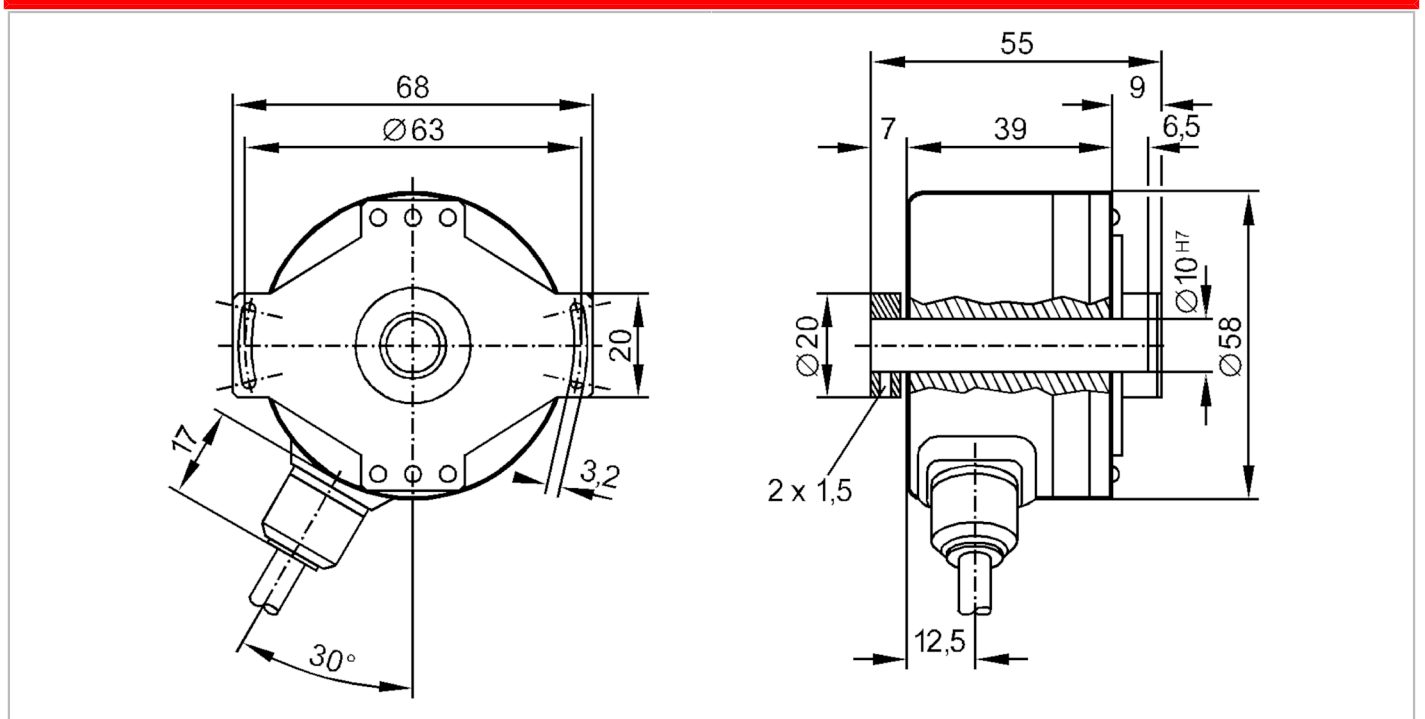

Product characteristics

Resolution	1024 resolution
Shaft design	continuous hollow shaft
Shaft diameter [mm]	10

Electrical data

Operating voltage tolerance [%]	10
Operating voltage [V]	5 DC
Current consumption [mA]	< 150

Outputs

Electrical design	TTL
Max. current load per output [mA]	20
Switching frequency [kHz]	300
Phase difference A and B [°]	90

Measuring/setting range

Resolution	1024 resolution
------------	-----------------

Operating conditions

Ambient temperature [°C]	-30...100
Storage temperature [°C]	-30...100
Max. relative air humidity [%]	98
Protection	IP 64

RO1328



Incremental encoder with hollow shaft

RO-1024-I05/N11

Tests / approvals	
Shock resistance	100 g (6 ms)
Vibration resistance	10 g (55...2000 Hz)
Mechanical data	
Dimensions [mm]	Ø 58 / L = 55
Materials	aluminium
Max. revolution, mechanical [U/min]	12000
Max. starting torque [Nm]	2.5
Reference temperature torque [°C]	20
Shaft design	continuous hollow shaft
Shaft diameter [mm]	10
Shaft fit	H7
Shaft material	stainless steel
Installation depth of shaft [mm]	10
Max. axial shaft misalignment [mm]	1; (max. radial shaft alignment: ± 0,05 mm)

Electrical connection

Cable: 1 m, PUR; radial

brown	A
green	A inverted
grey	B
pink	B inverted
red	0 index
black	0 index inverted
blue	L+ sensor
white	0V sensor
brown/green	L+ (Up)
white/green	0V (Un)
lilac	failure inverted
screen	housing

Diagrams and graphs

Pulse diagram

Output A
Output B
0 index

Article no longer available - archive entry