

# IF5271



## Inductive sensor

IFB3004-APOG/MS/ 6m

Article no longer available - archive entry

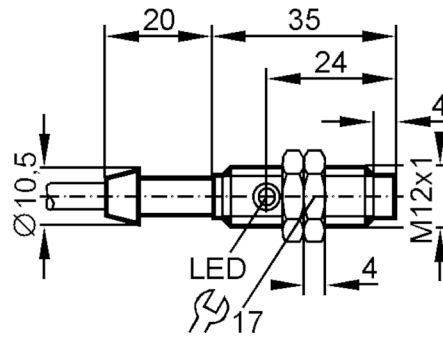

### Product characteristics

Electrical design	PNP
Output function	normally closed
Sensing range [mm]	4
Housing	threaded type
Dimensions [mm]	M12 x 1

### Electrical data

Operating voltage [V]	18...36 DC
Current consumption [mA]	7; (24 V)
Protection class	II
Reverse polarity protection	yes

### Outputs

Electrical design	PNP
Output function	normally closed
Max. voltage drop switching output DC [V]	2
Permanent current rating of switching output DC [mA]	200
Switching frequency DC [Hz]	400
Short-circuit protection	yes
Type of short-circuit protection	pulsed
Overload protection	yes

# IF5271



## Inductive sensor

IFB3004-APOG/MS/ 6m

Detection zone		
Sensing range	[mm]	4
Real sensing range Sr	[mm]	4 ± 10 %
Operating distance	[mm]	0...3.25
Accuracy / deviations		
Correction factor		steel: 1 / stainless steel: 0.7 / brass: 0.4 / aluminium: 0.3 / copper: 0.2
Hysteresis	[% of Sr]	1...15
Switch point drift	[% of Sr]	-10...10
Operating conditions		
Ambient temperature	[°C]	-25...80
Protection		IP 67
Mechanical data		
Housing		threaded type
Mounting		non-flush mountable
Dimensions	[mm]	M12 x 1
Thread designation		M12 x 1
Materials		brass nickel-plated; PBT
Displays / operating elements		
Display	switching status	1 x LED, yellow
Accessories		
Accessories (supplied)		lock nuts: 2
Remarks		
Pack quantity		1 pcs.

# IF5271



## Inductive sensor

IFB3004-APOG/MS/ 6m

### Electrical connection

Cable: 6 m, PVC; 3 x 0.34 mm<sup>2</sup>

### Connection



Core colours :

BN = brown  
BU = blue  
BK = black

Article no longer available - archive entry