

Continuous oil condition monitoring



Particle monitor LDP100 monitors the contamination of oils

- Analysis of particle concentration for trend monitoring
- Displays the cleanliness levels according to ISO 4406:99 or SAE AS4059E
- Robust aluminium die-cast housing for operating with pressures of up to 420 bar
- Intensely illuminated graphic display, intuitive push-button set-up
- CAN-Bus, analogue and switching outputs



Recognising contamination

LDP100 monitors the degree of cleanliness or the level of contamination in fluids. Compatible media are mineral oils, ester oils and biodegradable oils.

The integrated data memory allows data recording over a longer period. The LCD display indicates the cleanliness level.

Measuring principle

The optical particle monitor LDP100 operates according to the light extinction principle. The changes to light intensity of a laser beam caused by particles in the medium flowing through the measurement cell are detected by a photo detector. The calibration is made in accordance with ISO 11943.

Connection

On the fluid side the LDP100 is equipped with two Minimes connections with which the unit can be mounted in the off-line circuit of the oil cycle. The electrical connection is installed using an 8-pole M12-plug.



Δp-Q-characteristics for different viscosities

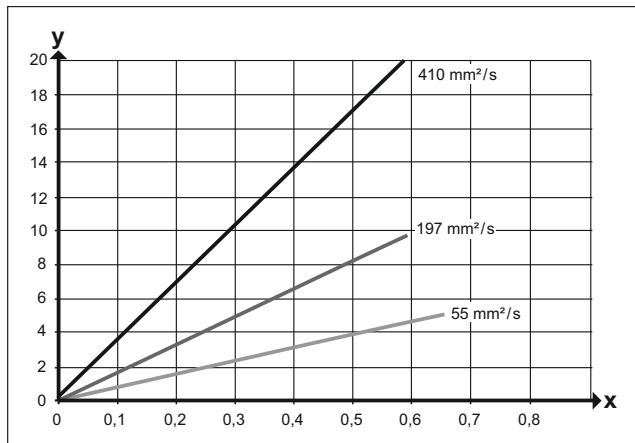



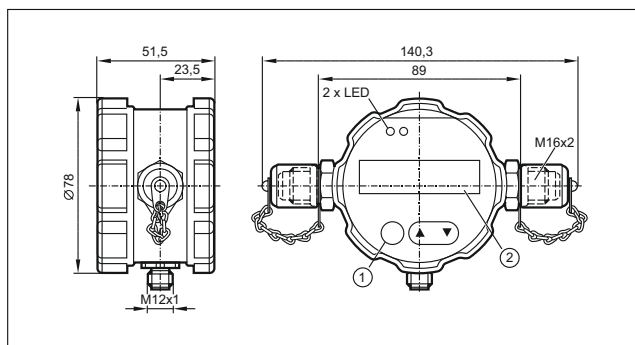

x: Volume flow in [l/min]
y: Δp in [bar]

Dimensions



1) Setbutton
2) LCD display



Accessories

Type	Description	Order no.
	Screw coupling, 0.18 mm	E43330
	Screw coupling, 0.3 mm	E43331
	CAN adapter cable	E43332
	BasicDisplay	CR0451

Technical data

Particle monitor LDP100		
Operating voltage	[V DC]	9...33
Current consumption	9 V	180 mA
	30 V	65 mA
Pressure range	[bar]	up to 420, dynamic
Flow	[ml / min]	50...400
Display		Cleanliness level according to ISO 4406:99 and SAE AS4059E
Size channels	[μm]	4, 6, 14, 21
Concentration limit		ISO 4...25 at 10 % optical coincidence
Temperature range	[°C]	
	Oil	-10...80
	Ambient Storage	-10...60 -20...60
Fluid compatibility		Mineral oils (e.g. HLP), ester oils (e.g. HEES) and biodegradable oils (e.g. HETG), phosphate ester optionally
Protection rating		IP 67 (with display IP 65)
Interface		analogue output 4...20 mA configurable, digital alarm output, digital input to start and stop readings
Data memory		3000 data records
Setting		Via push buttons or digital I/O
Electrical connection		M12 x 1, 8-pole
Process connection		Minimes M16 x 2
Wetted materials, sealing materials		High grade stainless steel, sapphire, NBR

Connection technology

Type	Description	Order no.
	M12 socket, 5 m, PUR cable, 8-pole	E12166
	M12 socket, 5 m, PUR cable, 8-pole	E12168