

Operating Instructions
IO-Link Master with Profinet interface
StandardLine
8 Ports
IP 65 / IP 67

AL1102

ifm firmware: 1.1.22 or higher
LR DEVICE: 1.1.0.87 or higher
IO-Link: 1.1.2

English

Contents

1	Preliminary note	5
1.1	Legal and copyright information	6
1.2	Purpose of the document	6
1.3	Symbols and styles used	6
1.4	Modification history	7
2	Safety instructions	8
2.1	General	9
2.2	Required background knowledge	9
2.3	Warnings used	9
2.4	Safety symbols on the device	10
2.5	Tampering with the unit	10
3	Functions and features	11
3.1	Permitted use	11
3.2	Prohibited use	11
4	Function	12
4.1	Communication, parameter setting, evaluation	13
4.1.1	IO-Link	14
4.1.2	Profinet	14
4.1.3	Parameter setting	14
4.1.4	Visual indication	14
4.2	Digital inputs	15
4.3	IO-Link supply	15
5	Mounting	16
5.1	Mount the device	16
6	Electrical connection	17
6.1	Ethernet ports	18
6.2	IO-Link ports	19
6.2.1	Input circuit	19
6.2.2	IO-Link circuits	20
6.3	Connect the device	21
7	Operating and display elements	22
7.1	Overview	23
7.2	LED indicators	24
7.2.1	Status LEDs	24
7.2.2	Ethernet interface	24
7.2.3	Voltage supply	25
7.2.4	IO-Link ports (Class A)	25

8	Configuration	26
8.1	Remarks	27
8.1.1	Supported configuration options	28
8.1.2	Connection possibilities	28
8.1.3	Offline parameter setting	31
8.1.4	VPN connection.....	31
8.2	LR DEVICE: Configure the device	32
8.2.1	Set-up.....	33
8.2.2	Configure communication profile	34
8.2.3	Configure the Ethernet interface.....	35
8.2.4	Configure the interface to the SmartObserver	36
8.2.5	Set the operating mode of the IO-Link ports.....	37
8.2.6	Set device validation and data storage.....	38
8.2.7	Reset IO-Link master to factory settings.....	40
8.3	LR DEVICE: Configure IO-Link devices	41
8.3.1	Offline parameter setting: Add IO-Link devices manually	42
8.4	Profinet: Configure the device.....	43
8.4.1	Install GSD file.....	44
8.4.2	Add the device to the Profinet network	45
8.4.3	Configure communication profile	47
8.4.4	IO-Link-Ports konfigurieren.....	48
8.4.5	Configure the Profinet interface	49
8.5	Profinet: Configure IO-Link devices	50
8.6	Profinet: Programmers' notes	50
8.6.1	Read and write I&M datasets	51
8.6.2	Detect diagnostics and alarms	51
8.6.3	Configure IO-Link devices	52
9	Operation	54
9.1	Identify device	55
9.2	Read device information	55
9.2.1	Web interface: Read device and diagnostic information.....	56
9.2.2	LR DEVICE: Read device information.....	57
9.2.3	Profinet: Read & write device information.....	57
9.3	Reboot the device	58
9.4	Error detection and elimination	58
9.5	Firmware update	59
9.6	Exchange IO-Link device	60
10	Maintenance	61
11	Factory settings	62
12	Appendix	63
12.1	Technical data.....	64
12.1.1	Application.....	65
12.1.2	Electrical data.....	65
12.1.3	Inputs / outputs.....	65
12.1.4	Inputs.....	65
12.1.5	Outputs.....	65
12.1.6	Interfaces.....	66
12.1.7	Operating conditions	66
12.1.8	Approvals / tests.....	66
12.1.9	Mechanical data	67

Preliminary note

12.1.10	Electrical connection	67
12.2	Profinet	68
12.2.1	Parameter data	69
12.2.2	Cyclic data	72
12.2.3	Acyclic data	75
13	Index	77
14	ifm weltweit • ifm worldwide • ifm à l'échelle internationale	79

© ifm electronic gmbh



www.ifm.com

1 Preliminary note

Contents

Legal and copyright information	6
Purpose of the document	6
Symbols and styles used.....	6
Modification history.....	7

14801



1.1 Legal and copyright information

1631

© All rights reserved by **ifm electronic gmbh**. No part of this manual may be reproduced and used without the consent of **ifm electronic gmbh**.

All product names, pictures, companies or other brands used on our pages are the property of the respective rights owners:

- AS-i is the property of the AS-International Association, (→ www.as-interface.net)
- CAN is the property of the CiA (CAN in Automation e.V.), Germany (→ www.can-cia.org)
- CODESYS™ is the property of the 3S – Smart Software Solutions GmbH, Germany (→ www.codesys.com)
- DeviceNet™ is the property of the ODVA™ (Open DeviceNet Vendor Association), USA (→ www.odva.org)
- EtherNet/IP® is the property of the →ODVA™
- EtherCAT® is a registered trade mark and patented technology, licensed by Beckhoff Automation GmbH, Germany
- IO-Link® (→ www.io-link.com) is the property of the →PROFIBUS Nutzerorganisation e.V., Germany
- ISOBUS is the property of the AEF – Agricultural Industry Electronics Foundation e.V., Deutschland (→ www.aef-online.org)
- Microsoft® is the property of the Microsoft Corporation, USA (→ www.microsoft.com)
- PROFIBUS® is the property of the PROFIBUS Nutzerorganisation e.V., Germany (→ www.profibus.com)
- PROFINET® is the property of the →PROFIBUS Nutzerorganisation e.V., Germany
- Windows® is the property of the →Microsoft Corporation, USA

1.2 Purpose of the document

22044

This document is only for device types "IO-Link master - Profinet gateway (StandardLine) 8 port IP 65 / IP 67" (art. no.: AL1102).

It is part of the device and contains information about the correct handling of the product.

- ▶ Read this document before using the device.
- ▶ Keep this document during the service life of the device.

1.3 Symbols and styles used

13839

...	Instructions
> ...	Reaction, result
→ ...	Cross-reference or internet link
123	Decimal number
0x123	Hexadecimal number
0b010	Binary number
[...]	Designation of pushbuttons, buttons or indications

1.4 Modification history

21676

Version	Topic	Date
00	New creation of document	31.05.2017



2 Safety instructions

Contents	
General.....	9
Required background knowledge.....	9
Warnings used.....	9
Safety symbols on the device.....	10
Tampering with the unit.....	10

2.1 General

22068



The plant manufacturer is responsible for the safety of the plant in which the device is installed.

If the device is used in a way that is not intended by the manufacturer, the protection supported by the device may be impaired.

Non-observance of the instructions, operation which is not in accordance with use as prescribed below, wrong installation or incorrect handling can affect the safety of operators and machinery.

- ▶ Observe these operating instructions.
- ▶ Adhere to the warning notes on the product.

2.2 Required background knowledge

22046

This document is intended for specialists. Specialists are people who, based on their relevant training and experience, are capable of identifying risks and avoiding potential hazards that may be caused during operation or maintenance of the product.

The document contains information about the correct handling of the product.

2.3 Warnings used

13685



WARNING

Designation of pushbuttons, buttons or indications



CAUTION

Slight reversible injuries may result.

NOTICE

Property damage is to be expected or may result.



Important note
Non-compliance may result in malfunction or interference.



Information
Supplementary note.

2.4 Safety symbols on the device

15021



General warning

When this symbol is shown, consult the corresponding section in the operating instructions.

2.5 Tampering with the unit

11242

WARNING

Tampering with the units can affect the safety of operators and machinery!

Tampering with the units is not allowed.

In case of non-compliance our liability and warranty expire.

- ▶ Do not open the devices!
- ▶ Do not insert any objects into the devices!
- ▶ Prevent metal foreign bodies from penetrating!

3 Functions and features

Contents	
Permitted use	11
Prohibited use.....	11

18761

3.1 Permitted use

22052

The device has been designed for use without a control cabinet in plant construction.

3.2 Prohibited use

22053

The device may not be used beyond the limits of the technical data (→ **Technical data** (→ p. [64](#)))!

© ifm electronic gmbh

4 Function

Contents

Communication, parameter setting, evaluation	13
Digital inputs	15
IO-Link supply.....	15

7482

© ifm electronic gmbh



4.1 Communication, parameter setting, evaluation

Contents	
IO-Link	14
Profinet	14
Parameter setting	14
Visual indication.....	14

7485



4.1.1 IO-Link

7773

The device offers the following IO-Link functions:

- IO-Link master for connection of up to 8 IO-Link devices (sensors, actuators) according to IO-Link standard 1.0 and 1.1.
- Provision of process data of the connected IO-Link devices for LR SMARTOBSERVER monitoring software (→ www.ifm.com)

4.1.2 Profinet

2259

The device offers the following Profinet functions:

- Provision of the functions of a Profinet RT Device (Class B)
- 2 port switch for access to the Profinet interface (X21/X22); intergrated switch IR and IRT conform according to Profinet V2.3
- Gateway for transmission of the process and parameter data between the connected IO-Link devices and the higher-level Profinet controller

4.1.3 Parameter setting

7771

The device provides the following configuration options:

- Parameter setting of the IO-Link master of the AL1102 with parameter setting software LR DEVICE and/or Profinet projection software
- Parameter setting of the connected IO-Link devices (sensors, actuators) with parameter setting software LR DEVICE and/or Profinet projection software
- Storage of parameter sets of the connected IO-Link devices for automatic recovery (data storage)

4.1.4 Visual indication

7772

The device has the following visual indicators:

- Status and error indication of the gateway, of the Profinet connection and of the system
- Status display of the voltage supply
- Status and activity display of the Ethernet connection
- Status, error and short circuit/overload indication of the IO-Link ports

4.2 Digital inputs

7584

The device has 8 digital inputs (type 2 according to EN 61131-2).

The digital inputs are on pin 2 of the IO-Link ports X01 ... X08.

All inputs refer to the potential of the device supply (pin 3).

4.3 IO-Link supply

7623

The device has 8 supplies for IO-Link devices (sensors, actuators).

The IO-Link ports X01...X08 are ports class A.

Every supply provides short circuit monitoring.

The device ensures fire protection for the connected IO-Link devices by providing a power-restricted circuit at the IO-Link ports (according to IEC61010-1).

5 Mounting

Contents

Mount the device	16
------------------------	----

22016

5.1 Mount the device

15540



- ▶ Disconnect the system from power before installation.
 - ▶ For installation choose a flat mounting surface.
 - ▶ Please observe the maximum tightening torque.
-
- ▶ Fix the unit to the mounting surface using 2 M5 mounting screws and washers.
 - Tightening torque: 1.8 Nm
 - ▶ Ground the unit via the two mounting screws of the upper mounting lugs.

6 Electrical connection

Contents

Ethernet ports	18
IO-Link ports	19
Connect the device	21

22017



A qualified electrician must connect the unit.

- ▶ Observe the national and international regulations for the installation of electrical equipment.

Device is only suitable for operation on SELV/PELV voltages.

- ▶ Observe the information concerning IO-Link circuits (→ **IO-Link circuits** (→ p. 20))!

The device contains components that can be damaged or destroyed by electrostatic discharge (ESD).

- ▶ Observe the required safety measures against electrostatic discharge!

The IP rating depends on the individual protection ratings of the unit, the applied connection elements and the corresponding protective covers.

- ▶ For UL applications: For connecting the device and the IO-Link devices use UL certificated cables of category CYJV or PVVA.

Wiring: → **Electrical connection** (→ p. 67)

6.1 Ethernet ports

22683



Notes on connection possibilities: → **Connection possibilities** (→ p. [28](#))

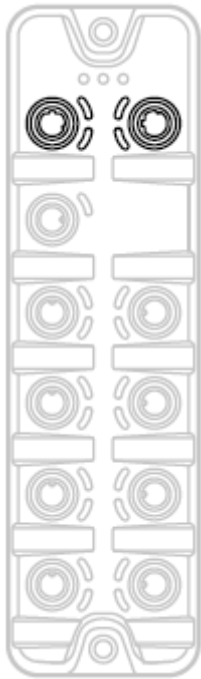

- ▶ Connect the unit via the M12 socket X21 and/or X22 with the Profinet network (e.g. Profinet PLC, additional Profinet device)
 - Tightening torque: 0.6...0.8 Nm
- ▶ Connect the unit via the M12 socket X21 and/or X22 to the industrial Ethernet network (e.g. laptop/PC with installed parameter setting software LR DEVICE, laptop/PC with installed monitoring software LR SmartObserver)
 - Tightening torque: 0.6...0.8 Nm
- ▶ For the connection, use M12 connectors with protection rating IP 65 / IP 67 or higher (e.g. E12492).
- ▶ Cover the unused sockets with M12 protective caps (art. no.: E73004).
 - Tightening torque 0.6...0.8 Nm

6.2 IO-Link ports

22684

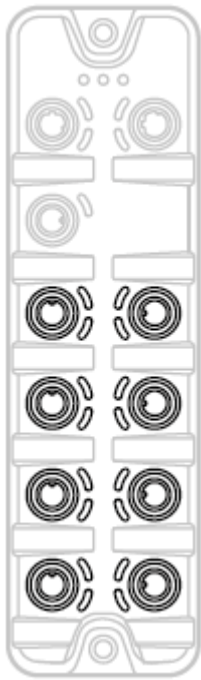

Ports X01...X08: For use as IO-Link port class A:

- ▶ Connect the connector of the IO-Link devices with the M12 sockets X01 ... X08.
 - Tightening torque: 0.6...0.8 Nm
 - Maximum cable length per IO-Link interface: 20 m
- ▶ For the connection, use M12 connectors with protection rating IP 65 / IP 67 or higher (e.g. EVC493).

Ports X01...X08: For use as IO-Link port class B:

- ▶ Connect the connector of the IO-Link devices via the adapter with the M12 sockets X01 ... X08.
 - Tightening torque: 0.6...0.8 Nm
- ▶ To connect the devices, use M12 connectors with protection rating IP 65 / IP 67 or higher (e.g. EVC693).
- ▶ Cover the unused sockets with M12 protective caps (art. no.: E73004).
 - Tightening torque 0.6...0.8 Nm

6.2.1 Input circuit

18629

The inputs of the M12 sockets 8 (pin 2) provide a type 2 behaviour according to standard EN61131-2, the connected electronics must be rated for this electrically.

6.2.2 IO-Link circuits

11616

The IO-Link interfaces of the device meet the requirements of the IO-Link specification 1.0 to 1.1.2.



The connected IO-Link devices may only be supplied via the AL1102.

Exception: Connection of IO-Link devices to ports X01...X08 via suitable connection technology for port class B operation (→ **IO-Link ports** (→ p. 19)):

The external supply for port class B operation must be galvanically separated from the circuit of the AL1102 by assuring basic isolation (according to EN61010-1, secondary circuit with maximum 30 V DC derived from applied voltage up to 300 V of overvoltage category II)!

The isolation must be done both for IO-Link devices and for the connection technology.

NOTICE

Risk of material damage

If the requirements of galvanic separation of the circuits are not observed, the fire protection of the device can not be assured.

- ▶ Observe the requirements of the electrical connection of IO-Link devices for port class B operation!

Further information: → **Technical data** (→ p. 64)

6.3 Connect the device

2580

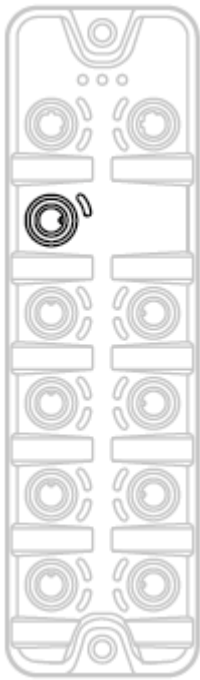

- ▶ Disconnect power.
- ▶ Connect the device via M12 socket X31 to 24 V DC (20...30 V SELV/PELV; according to EN61010-1, secondary circuit with maximum 30 V DC derived from applied voltage up to 300 V of overvoltage category II).
 - Tightening torque: 0.6...0.8 Nm
 - Maximum cable length: 25 m
- ▶ To connect the device, use M12 connectors with protection rating IP 65 / IP 67 or higher (e.g. EVC708).

If the port X01...X08 will be used as IO-Link ports Class B:

- ▶ Connect adapter for Port Class B operation to 24 V DC (20...30 V SELV/PELV) (→ **IO-Link ports** (→ p. [19](#)))

7 Operating and display elements

Contents

Overview.....	23
LED indicators	24

5440

© ifm electronic gmbh



www.ifm.com

7.1 Overview

22025

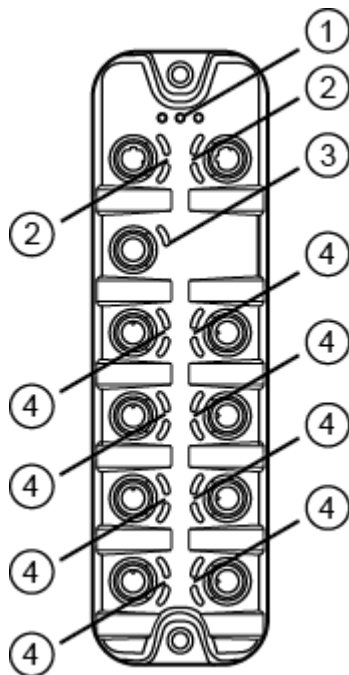

- ① Status LEDs RDY, BF und SF
→ **Status LEDs** (→ p. [24](#))
- ② Status LEDs LNK and ACT of the Profinet ports 1 (X21) and 2 (X22)
→ **Ethernet interface** (→ p. [24](#))
- ③ Status LED US of the power supply (X31)
→ **Voltage supply** (→ p. [25](#))
- ④ Status LEDs IOL and DI of the IO-Link ports Class A (X01...X08)
→ **IO-Link ports (Class A)** (→ p. [25](#))

7.2 LED indicators

22024

The device only has the following LED indicators:

7.2.1 Status LEDs

22034

The RDY LED shows the status of the gateway.

The BF LED (Bus Failure) shows the status of the Profinet connection.

The SF LED (System Failure) shows the status of the system.

Status LED			Description
RDY	green	on	Gateway functions properly
		flashes 1 Hz	Error
		flashes 5 Hz	Firmware update
		off	Gateway does not function; Unit reboots
BF	red	on	Bus error
		flashes 1 Hz	No connection to the Profinet controller
		off	error-free
SF	red	on	<ul style="list-style-type: none"> ▪ Error in gateway ▪ At least 1 IO-Link device sends warning / alarm (temperature, over/under current, over/under voltage, shortcut)
		off	error-free

7.2.2 Ethernet interface

22027

Each Ethernet interface (X21, X22) has 2 LEDs (LNK and ACT). The LEDs indicate the status of the Ethernet connection.

Status LED			Description
LNK	green	on	Ethernet connection established
		off	No Ethernet connection
ACT	yellow	flashes	Data is transmitted via the Ethernet interface.
		off	No data transmission

7.2.3 Voltage supply

22026

The interface for voltage supply (X31) has the LED that is marked as US. The LED indicates the status of the voltage supply.

Status LED			Description
US	green	on	The supply voltage U_s is applied.
		off	No supply voltage is applied or the applied supply voltage is too low.

7.2.4 IO-Link ports (Class A)

22029

Each IO-Link port Class A (X01 ... X08) has 2 LEDs marked as IOL and DI. The LEDs indicate the status of the IO-Link port.

Status LED			Description
IOL	yellow	on	Interface configured as DI/DO: Pin 4 (C/Q) = ON
		off	Interface configured as DI/DO: Pin 4 (C/Q) = OFF
	green	on	IO-Link transmission functions properly
		flashes 1 Hz	Interface configured as IO-Link, but no IO-Link transmission
	red	on	Short circuit or overload in supply voltage
		flashes 1 Hz	Transmission error
DI	yellow	on	Digital input: Pin 2 (DI) = ON
		off	Digital input : Pin 2 (DI) = OFF

8 Configuration

Contents

Remarks	27
LR DEVICE: Configure the device	32
LR DEVICE: Configure IO-Link devices	41
Profinet: Configure the device	43
Profinet: Configure IO-Link devices.....	50
Profinet: Programmers' notes	50

22367

8.1 Remarks

Contents	
Supported configuration options.....	28
Connection possibilities.....	28
Offline parameter setting.....	31
VPN connection.....	31

22369



8.1.1 Supported configuration options

22408

The AL1102 can be configured using the following options:

- Parameter setting software LR DEVICE (version 1.1.0.87 or higher) (art. no.: QA0011/QA0012)
- Profinet projection software Siemens STEP 7 (version 5.5 or higher, service pack 4)
- Profinet projection software Siemens TIA portal

8.1.2 Connection possibilities

12742

Via the two Profinet interfaces X21 and X22, the AL1102 can be simultaneously connected with the Profinet control level (PLC) and the IT infrastructure level (monitoring/parameter setting). The following connection possibilities exist:

Operation without Profinet connection

4364

Operation as independent IO-Link master with connected IO-Link devices. As an option, several IO-Link masters can be coupled via the Profinet interfaces. If necessary, the IO-Link masters can be coupled with the IT infrastructure via industrial Ethernet in order to enable monitoring of the process data of the connected IO-Link devices.

Parameter setting

- IO-Link master: LR DEVICE
- IO-Link device: LR DEVICE

Monitoring (optional):

LR SmartObserver

Topology (example):

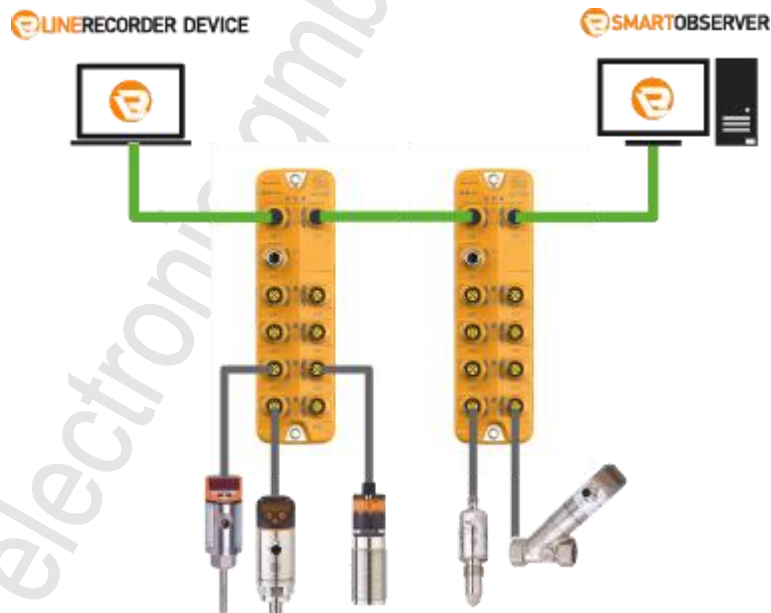

Operation with Profinet connection (without LR DEVICE)

7396

Operation of the IO master as Profinet IO device. As an option, several IO-Link masters can be coupled via the Ethernet interfaces X21 and X22. The complete monitoring of the process data and processing of alarms takes place via Profinet mechanisms.

Parameter setting

- IO-Link master: Profinet projection software
- IO-Link device: Profinet projection software (acyclic services)

Monitoring:

Profinet projection software

Topology (example):

Feldbus

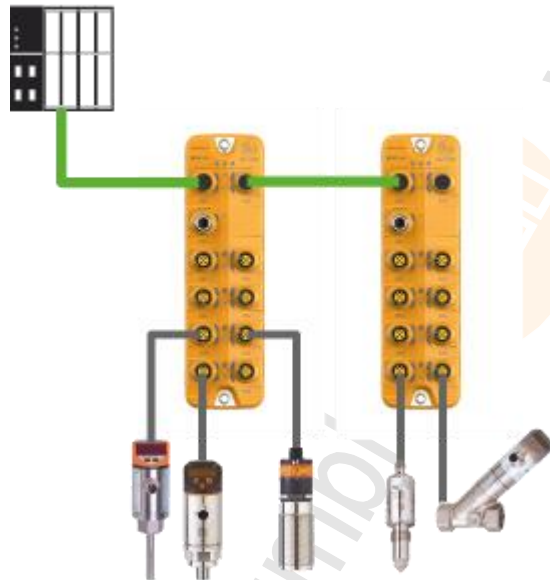

© ifm electronic gmbh www.ifm.com

Operation with Profinet connection and LR DEVICE/LR SmartObserver

7398

The AL1102 can be connected via the two Ethernet interfaces X21 and X22 simultaneously with the Profinet control level (PLC) and the IT infrastructure level (monitoring/parameter setting).

Parameter setting

- IO-Link master: LR DEVICE and/or Profinet projection software
- IO-Link device: LR DEVICE and/or Profinet projection software

Monitoring:

LR SmartObserver and/or Profinet projection software

Topology (example):

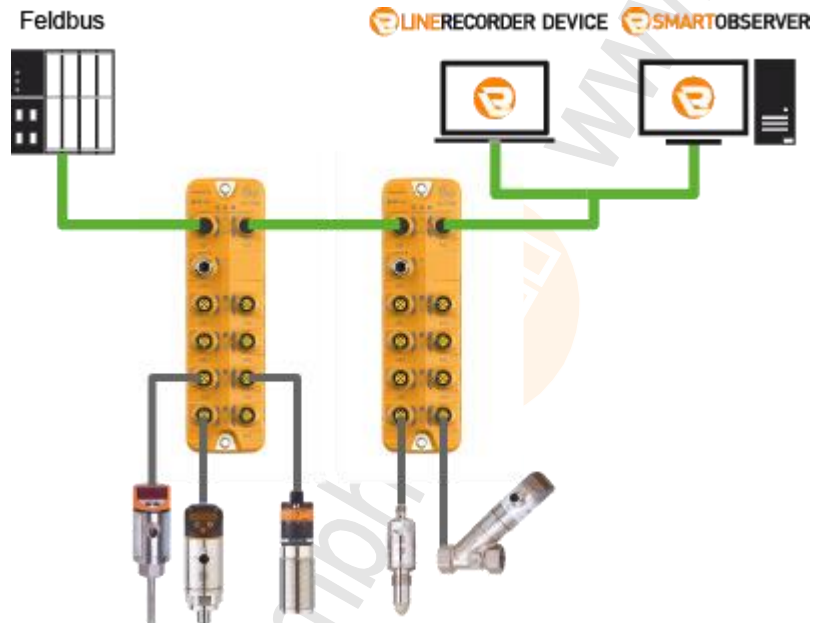

8.1.3 Offline parameter setting

SYS_OBJECTID>

The AL1102 supports the offline parameter setting. In this context, the user creates and stores a configuration for the unit and the connected IO-Link devices without being connected to the AL1102. The configuration created in this way can be stored as a file (*.lrp) and loaded to the device and activated at a later date.



Further information about offline parameter setting: → Operating instructions of the parameter setting software LR DEVICE

8.1.4 VPN connection

22762



An active VPN connection blocks the access of the parameter setting software LR DEVICE to the Profinet interface of the AL1102.

- ▶ Deactivate the VPN connection in order to be able to access the AL1102 with the LR DEVICE.

8.2 LR DEVICE: Configure the device

Contents	
Set-up	33
Configure communication profile	34
Configure the Ethernet interface	35
Configure the interface to the SmartObserver.....	36
Set the operating mode of the IO-Link ports	37
Set device validation and data storage	38
Reset IO-Link master to factory settings	40

22402

The IO-Link master and the IO-Link devices connected to the AL1102 can be configured with the ifm software LR DEVICE.



Further information about operation and functions of the LR DEVICE parameter setting software:

- ▶ Use the help function of the parameter setting software LR DEVICE!

In order to configure the AL1102 with the LR DEVICE.

- ▶ Put AL1102 into operation (→ **Set-up** (→ p. [33](#))).
- ▶ Under [ONLINE]: Click on the AL1102.
- > LR DEVICE shows the following sections:

Section	Functions
[All]	all available functions
[Network]	→ Configure the Ethernet interface (→ p. 35)
[LineRecorder]	→ Configure communication profile (→ p. 34) → Configure the interface to the SmartObserver (→ p. 36)
[Port x]*	→ Set the operating mode of the IO-Link ports (→ p. 37) → Set device validation and data storage (→ p. 38)
[Setup]	→ LR DEVICE: Read device information (→ p. 57) → Reset IO-Link master to factory settings (→ p. 40) → Reboot the device (→ p. 58)

* ... x = 1...8

8.2.1 Set-up

12759

On delivery, the AL1102 is configured with the → **Factory settings** (→ p. 62)

Before configuration with the LR DEVICE parameter setting software, the user must put the device into operation. During set-up, the IP settings are configured via the Profinet interface (X21/X22).

In order to put the device into operation with LR DEVICE:

Prerequisites

- > The device is configured with the factory settings.
- > The device is properly connected with the LR DEVICE laptop/PC via the Profinet interface.
- > LR DEVICE is started

1 Scan network

- ▶ Scan network for new IO-Link masters.
- > The following information is given under [ONLINE]:
 - Article number (AL1102)
 - MAC-ID of the device

2 Set network parameters

- ▶ Under [ONLINE]: Click on [AL1102].
- > LR DEVICE shows all current network settings
- ▶ Set the following parameters as required:

Parameters	Description	Possible values
[IP address]	IP address of the device	e.g. 172.18.65.50
[Subnet mask]	Subnet mask of the IP network	e.g. 255.255.255.0
[IP gateway address]	IP address of the network gateway	e.g. 172.18.65.0
[Profinet name]	Device name in the Profinet parameter setting software	▶ Observe the note!



When giving the Profinet name, the following restrictions apply:

- Permitted characters:
 - Lower case a-z
 - Numbers 0-9
 - Separators: Point, minus sign
- Restrictions:
 - The name may not end with a point or minus sign
 - The name may not begin with a number
 - The minus sign may not be directly before or after a point

- ▶ Write the changed values to the device.
- > LR DEVICE stores the changed values on the device.

If successful:

- > In the [ONLINE] area: Under [Geräte], the Profinet name of the AL1102 appears.
- > LR DEVICE shows options for device configuration.

8.2.2 Configure communication profile

22061

In order to copy the access rights to the device:

- ▶ Select the [LineRecorder] menu.
- > The page shows the current settings.
- ▶ Set the following parameter as required:

Parameter	Description	Possible values	
[Communication Profile]	Access rights to the parameter data, process data and event/diagnostic messages of the IO-Link master and the connected IO-Link devices	Profinet + LineRecorder	<ul style="list-style-type: none"> ▪ Profinet and LR DEVICE have read and write access rights to parameters and process data ▪ Profinet and LR DEVICE have read access rights to events/alarms
		Profinet + LineRecorder (ro)	<ul style="list-style-type: none"> ▪ Profinet has read and write access rights to parameters and process data ▪ Profinet has read access rights to events/alarms ▪ LR DEVICE only has read access rights to parameters, process data and events/alarms
		LineRecorder only	<ul style="list-style-type: none"> ▪ LR DEVICE has read and write access rights to parameters to parameters and process data ▪ LR DEVICE has read access rights to events/alarms ▪ Profinet has no access rights
		keep setting	Previous settings are valid

- ▶ Store changed values on the device.



If parameter [Communication Profile] = Profinet + LineRecorder:

Different parameter settings in the Profinet projection software and the LR DEVICE may cause undesired system behaviour. Parameter settings applied by the Profinet projection software always overrule the settings applied by LR DEVICE.



Changes of the parameter [Access Rights] are only effective after restarting the device.

To activate the changed access rights:

- ▶ → **Reboot the device** (→ p. 58)

8.2.3 Configure the Ethernet interface

22404

To set the parameters of the Profinet interface (X21/X22):

- ▶ Select the [Network] menu.
- > The page shows the current settings.
- ▶ Set the following parameters as required:

Parameters	Description	Possible values
[IP address]	IP address of the device	e.g. 172.18.65.50
[Subnet mask]	Subnet mask of the IP network	e.g. 255.255.255.0
[IP gateway address]	IP address of the gateway	e.g. 172.18.65.1
[Profinet name]	Name of the device in the Profinet network*	e.g. al1xxx
[MAC address]	MAC address of the device	The value is fixed

* ... observe the restrictions concerning the naming conventions (→ **Set-up** (→ p. [33](#)))!

- ▶ Store changed values on the device.

8.2.4 Configure the interface to the SmartObserver

12743

In order to set the parameters of the interface to the SmartObserver:

- ▶ Select the [LineRecorder] menu.
- > The page shows the current settings.
- ▶ Set the following parameters as required:

Name	Description	Possible values	
[IP address SmartObserver]	IP address of the laptop/PC where the SmartObserver is installed	e.g. 192.168.0.100	
[Port SmartObserver]	Port address that is used to send process data to the SmartObserver	1 ... 65535	Default value: 35100
[Source ID SmartObserver]	Source identifier with which the process data of the device is indicated in the SmartObserver (String32)		
[Port x. LR events]	Operating mode of the IO-Link port (x = 1...8)	Disabled	Cyclic transfer of the process data
		Enabled	Event-based transfer of the process data
[Port x. LR cycle time (ms)]*	Cycle time of the IO-Link interface for cyclic transmission of the process data between the IO-Link master and the SmartObserver (x = 1...8)	Disabled	no data transmission
		1000 ... 60000	1000 ms ... 60000 ms

* ... parameter only valid if parameter [PortX. LR events] = Disabled



After changing the parameter [Port SmartObserver] or [Source ID SmartObserver], it can take 120 seconds before the device establishes a new TCP connection.

To prevent the delay:

- ▶ Reboot the device after the parameter change.
- ▶ Store changed values on the device.

8.2.5 Set the operating mode of the IO-Link ports

8714

The IO-Link ports X01...X08 of the device support the following operating types:

- Digital input (DI): binary input signal on pin 4 (C/Q) of the IO-Link port
- Digital output (DO): binary output signal on pin 4 (C/Q) of the IO-Link port
- IO-Link interface (IO-Link): IO-Link data transfer via pin 4 (C/Q) of the IO-Link port

The user can set the operating mode of each IO-Link port separately at any time.

- ▶ Select [Port x] menu.
- > The page shows the current settings.
- ▶ Set the following parameters as required:

Name	Description	Possible values	
[Port x mode]	Operating mode of the IO-Link port (x = 1...8)	IO-Link	Operation as IO-Link interface
		DI	Operation as digital input
		DO	Operation as digital output
		Disabled	Interface deactivated
[Port x IO-Link. Cycle time]*	Cycle time of the data transmission between the IO-Link master and the IO-Link device	As fast as possible	The device automatically sets the fastest possible cycle time
		2.0 ms	2 milliseconds
		... 128.0 ms	... 128 milliseconds

* ... Parameter only available, if [Port x mode] = IO-Link

- > Store the changed values on the AL1102.

8.2.6 Set device validation and data storage

7165

In operating mode "IO-Link" the user can set the behaviour of the IO-Link ports regarding device validation and backup/restore of parameter data of the connected IO-Link devices.

To configure the device validation and data storage settings:

- ▶ Select [Port x] menu.
- > The page shows the current settings.
- ▶ Set the following parameters as required:

Name	Description	Possible values	
[Port x IO-Link Validation / Data Storage]	Supported IO-Link standard and behaviour of the device when a new IO-Link device is connected to IO-Link port x (x = 1...8)	No check and clear	<ul style="list-style-type: none"> ▪ No verification of the vendor ID and device ID ▪ No data storage
		Type compatible V1.0 device	<ul style="list-style-type: none"> ▪ IO-Link device is compatible with the V1.0 IO-Link standard ▪ Verification whether it is an IO-Link device of the same type (validation via vendor ID and device ID) ▪ No data storage
		Type compatible V1.1 device	<ul style="list-style-type: none"> ▪ IO-Link device is compatible with the V1.1 IO-Link standard ▪ Verification whether it is an IO-Link device of the same type (validation via vendor ID and device ID) ▪ no data storage
		Type compatible V1.1 device with Backup + Restore	<ul style="list-style-type: none"> ▪ IO-Link device is compatible with the V1.1 IO-Link standard ▪ Verification whether it is an IO-Link device of the same type (validation via vendor ID and device ID) ▪ The IO-Link master saves the parameter values of the connected IO-Link device; modifications of the parameter values are also stored (observe the note!) ▪ When connecting an IO-Link device with factory settings, the parameter values stored in the IO-Link master are restored automatically on the IO-Link device.

Configuration

Name	Description	Possible values	
		Type compatible V1.1 device with Restore	<ul style="list-style-type: none"> ▪ IO-Link device is compatible with the V1.1 IO-Link standard ▪ Verification whether it is an IO-Link device of the same type (validation via vendor ID and device ID) ▪ The IO-Link master saves the parameter values of the connected IO-Link device once. ▪ When connecting an IO-Link device with factory settings, the parameter values stored in the IO-Link master are restored automatically on the IO-Link device.
[Port x IO-Link. Vendor ID]	ID of the manufacturer that is to be validated	0 ... 65535	ID of the manufacturer of the IO-Link device (ifm electronic: 310)
[Port x IO-Link. Device ID]	ID of the IO-Link device that is to be validated	0 ... 16777215	ID of the IO-Link device

- ▶ Store the changed values on the AL1102.

© ifm electronic gmbh

8.2.7 Reset IO-Link master to factory settings

12740

When resetting the AL1102, all parameters are reset to the → **Factory settings** (→ p. [62](#))

To reset the device to factory settings:

- ▶ Select [Setup] menu.
- > The page shows the current settings.
- ▶ Click on [Factory Reset] to reset the AL1102.
- > LR DEVICE sets the AL1102 factory settings.

8.3 LR DEVICE: Configure IO-Link devices

22403

In order to configure the IO-Link devices connected to the AL1102 using the parameter setting software LR DEVICE:

Requirements:

- > AL1102 is correctly installed and connected to the LR DEVICE software via the Profinet interface (X21/X22).
- > The IO-Link device is connected correctly with the AL1102.
- > The operating mode of the IO-Link interface is "IO-Link" (parameter [Port x mode] = IO-Link)
- > Parameter [Access rights] is configured with one of the following values:
 - Profinet + LineRecorder
 - LineRecorder only

1 Select IO-Link master

- ▶ Start LR DEVICE.
- ▶ Update IODD file library
OR:
Import IODD file of the IO-Link device manually.
- ▶ Scan network for devices.
- > LR DEVICE recognises all IO-Link masters of the Profinet network.

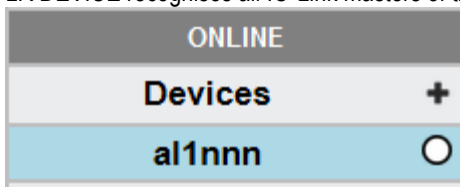

2 Add IO-Link device

- ▶ Under [ONLINE]: Click on the required AL1102.
- > LR DEVICE automatically detects the IO-Link devices connected to the AL1102 (e.g. ifm Sensor KG5065).

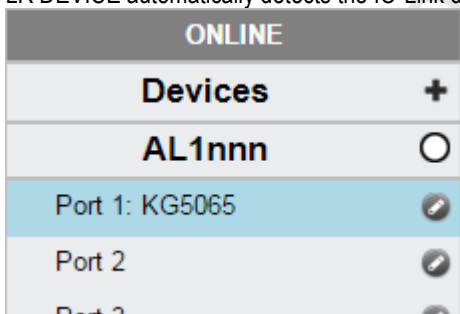

3 Configure IO-Link device

- ▶ Mouse click on the port to which the IO-Link device is connected.
- > LR DEVICE reads and shows the current parameter values of the IO-Link device.
- ▶ Configure IO-Link device.



Information about the available parameters of the IO-Link device: → Operating instructions of the IO-Link device

- ▶ Store changed configuration on the IO-Link device.

8.3.1 Offline parameter setting: Add IO-Link devices manually

22817

The AL1102 supports the automatic recognition of IO-Link devices that are connected to the IO-Link interfaces. In addition to the automatic recognition of IO-Link devices in the online mode, the user can also manually add IO-Link devices to the device configuration (e.g. → **Offline parameter setting** (→ p. 31)).

1 Set up offline configuration

- ▶ Start LR DEVICE.
- ▶ Add AL1102 to an offline configuration.
- > LR DEVICE shows AL1102 in [OFFLINE] section.

2 Add IO-Link device to configuration.

- ▶ Under [OFFLINE]: Click on [AL1102].
- > LR DEVICE shows the available parameters of the AL1102.
- ▶ Click on the symbol at the required port.

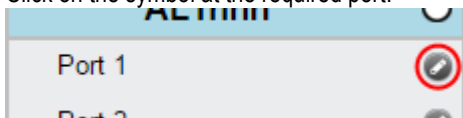

- > The dialogue window [Gerät auswählen] appears.
- ▶ Select the required IO-link device from the list.
- ▶ Click on [OK] to add the selected IO-Link device to the device configuration.
- > IO-Link device appears at the selected port.

3 Configure IO-Link device

- ▶ Mouse click on the port to which the IO-Link device is connected.
- > LR DEVICE shows the available parameters of the IO-Link device.
- ▶ Configure IO-Link device.



Information about the available parameters of the IO-Link device: → Operating instructions of the IO-Link device

- ▶ Store changed configuration on the IO-Link device.
- ▶ Click on [AL1102].

8.4 Profinet: Configure the device

Contents

Install GSD file	44
Add the device to the Profinet network	45
Configure communication profile	47
IO-Link-Ports konfigurieren	48
Configure the Profinet interface	49

22758

On the field bus side, the device can be configured with the following options:

- Profinet projection software STEP 7 (version 5.5 SP 4 or higher)
- Profinet projection software TIA portal



Further information about operation and functions of the Profinet parameter setting software:

- ▶ Use the help function of the Profinet projection software!

8.4.1 Install GSD file

22410

To represent the AL1102 in a field bus projection software (e.g. STEP 7), ifm provides a GSD file. The user can download the GSD file from the ifm website (→ the GSD file, all parameters, process data, and their valid value ranges are defined).

To add the AL1102 to the STEP 7 hardware catalogue:

- ▶ Download GSD file of the AL1102 from the ifm website.
- ▶ Start STEP 7 application "HW Config".
- ▶ Select [Options] > [Install GSD files...].
- > The [Install GSD files] window appears.
- ▶ Click on [Browse ...].
- ▶ Select the GSD file of the AL1102 and click on [OK] to adopt the file.
- > The selected GSD file appears in the list.
- ▶ Select the GSD file in the list and click on [Install].
- > STEP 7 installs the GSD file and adds the AL1102 to the hardware catalogue.

After installation of the GSD file, the AL1102 is in the hardware catalogue in the following folder:

- > [PROFINET IO] > [Additional Field Devices] > [IO] > [ifm electronic]

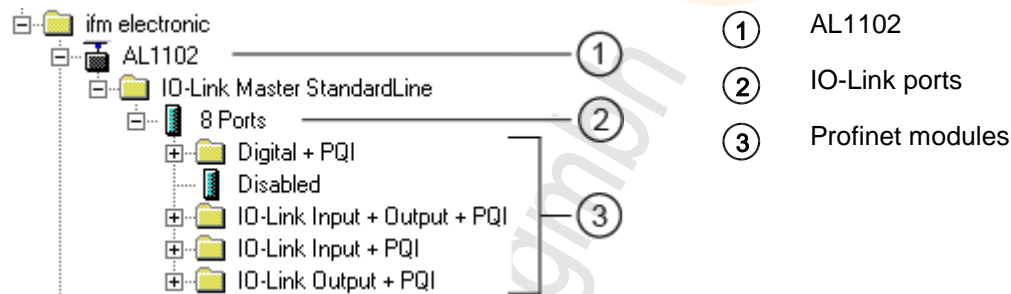

8.4.2 Add the device to the Profinet network

22406

The configuration of the Profinet parameters is done via the Profinet projection software.

The Profinet parameters define which data is transmitted between AL1102 and the higher-level Profinet controller.

Requirements:

- > Profinet has read and write permission on the AL1102 (→ **Configure communication profile** (→ p. 34))
- > The GSD file of the AL1102 is installed (→ **Install GSD file** (→ p. 44))

1 Create/open project

- ▶ Create new Profinet project.
OR
Open an existing Profinet project.
- ▶ Configure Profinet connection.

2 Add the AL1102 to project

- ▶ Open STEP-7 application "HW Config".
- > Program window shows the hardware structure of the project.
- ▶ Open hardware catalogue.
- ▶ Move the [AL1102] node via drag&drop from the hardware catalogue to the Profinet connection.
- > STEP 7 shows the device as Profinet bus participant.

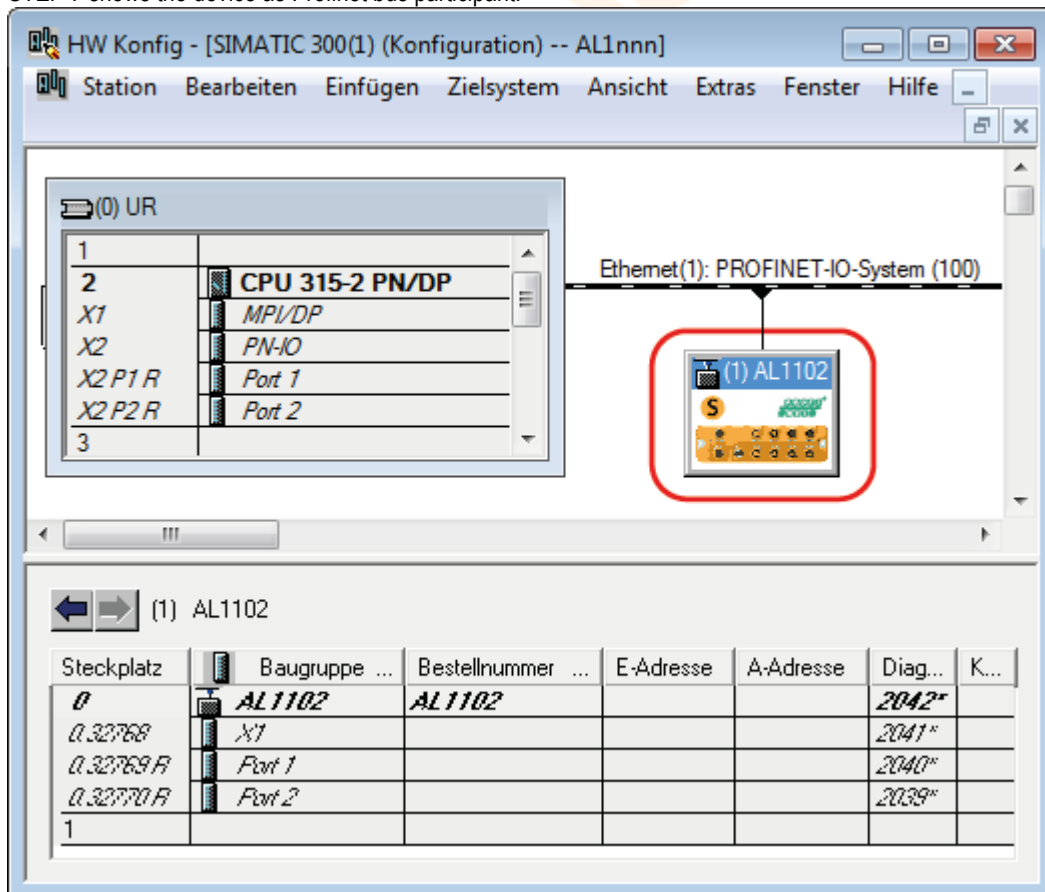

3 Add IO-Link ports

- ▶ Move the [8 Ports] node via drag&drop from the hardware catalogue to slot 1 of the AL1102.
- > Step 7 shows available IO-Link interfaces.

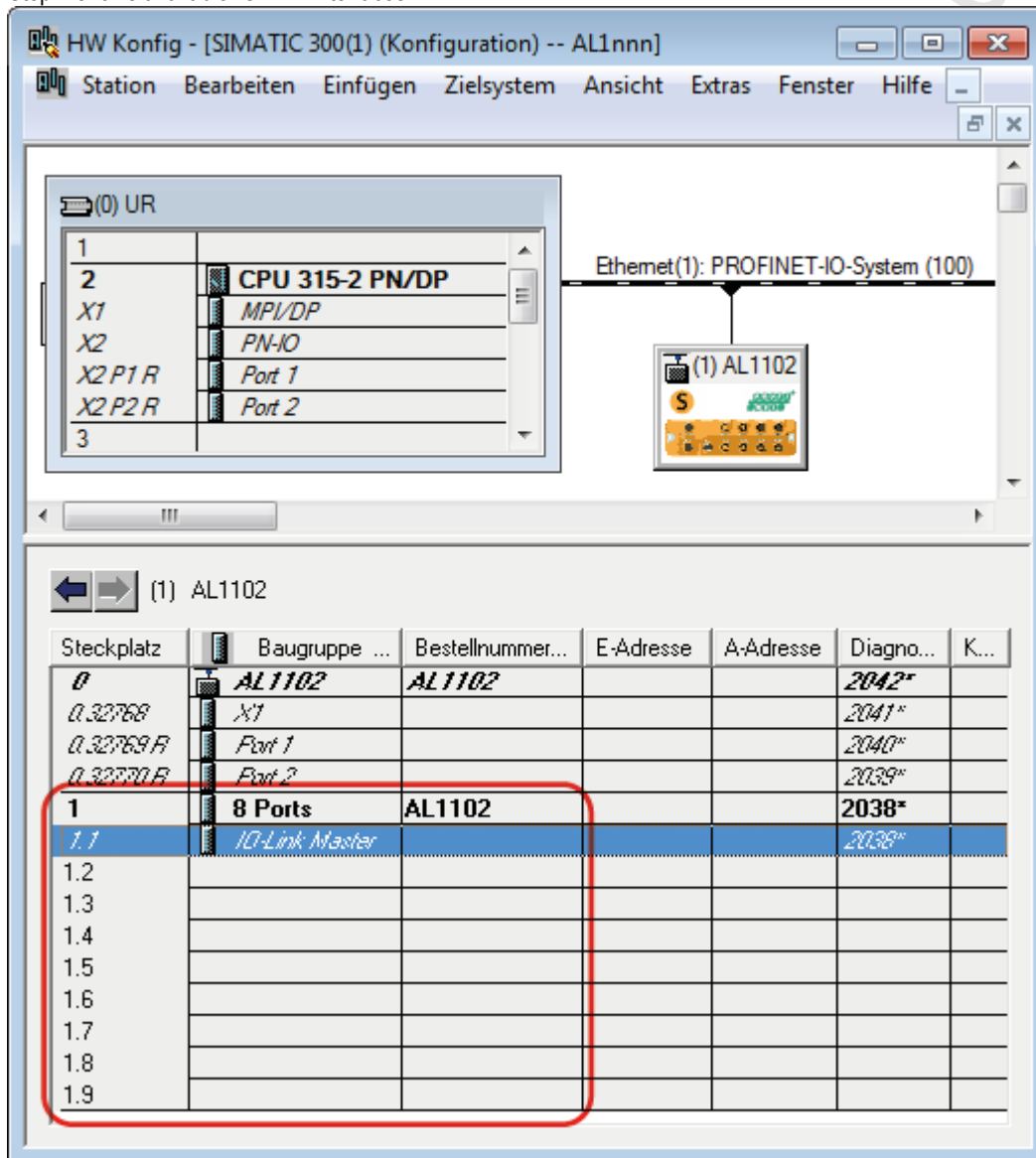

- ▶ Save the project.

8.4.3 Configure communication profile

22760

In order to configure the access rights to the device:

1 Open device editor

- ▶ Open STEP-7 application "HW Konfig".
- > Program window shows the hardware structure of the project.
- ▶ Click on AL1102.
- > The device editor shows the current configuration of the AL1102.

2 Configure access rights

- ▶ Double click on the slot line [1.1 IO-Link Master]

Slot	Name	Description
1.1	IO-Link Master	
1.2		

- > The window [Properties IO-Link master] appears.
- ▶ Select [Parameters] tab.
- ▶ Set the following parameter as required:
 - Communication Profile (→ **Parameter of the IO-Link master** (→ p. 69))
- ▶ Click on [Hinzufügen] to save the changes.



If parameter [Communication Profile] = Profinet + LineRecorder:

Different parameter settings in the Profinet projection software and the LR DEVICE may cause undesired system behaviour. Parameter settings applied by the Profinet projection software always overrule the settings applied by LR DEVICE.



Changes of the parameter [Communication Profile] are only effective after restarting the device.

To activate the changed access rights:

- ▶ → **Reboot the device** (→ p. 58)

8.4.4 IO-Link-Ports konfigurieren

22628

In STEP 7, the following assignment of the Profinet slots to the IO-Link ports of the device applies:

Slot	Sub-slot	IO-Link interface of the AL1102
1	2	X01
	3	X02
	4	X03
	5	X04
	6	X05
	7	X06
	8	X07
	9	X08

Each sub-slot can be configured for cyclic transmission of process data with a Profinet module. The selected Profinet module determines the operation type of the IO-link interface and the configurable parameters.

Overview of the available Profinet modules: → **Profinet modules** (→ p. 73)

To add a Profinet module to a sub-slot:

1 Open device editor

- ▶ In "HW Config": Click on AL1102.
- > The device editor shows the current configuration of the AL1102.

2 Add Profinet module

- ▶ Open hardware catalogue.
- ▶ Draw the required Profinet module of the AL1102 from the hardware catalogue to the slot.
- > The device editor shows the slot with the selected Profinet module.

3 Set parameters of the Profinet module

- ▶ Double click on the added slot.
- > Window [Properties] appears.
- ▶ Select [Parameters] tab.
- > The page shows the current parameter settings of the IO-Link ports.
- ▶ Set the parameters as required (marked with X in table):

Operating mode of the IO-Link ports	Available parameters					
	Fail Safe Mode	Pattern Value	Validation / Data storage	Vendor ID (VID)	Device ID	Port cycle time
DI: Digital input	--	--	--	--	--	--
DO: Digital output	X	--	--	--	--	--
IO-Link: Input	--	--	X	X	X	X
IO-Link: Output	X	X	X	X	X	X
IO-Link: Input and output	X	X	X	X	X	X



Further information about the parameters of the Profinet modules: → [Parameters of the IO-Link ports](#) (→ p. [70](#))

- ▶ Click on [Add] to save the changes.
- > Changed settings are applied.

8.4.5 Configure the Profinet interface

22761

In order to configure the Ethernet interface of the AL1102:

Prerequisites

- > AL1102 is correctly integrated in the Profinet project (→ [Add the device to the Profinet network](#) (→ p. [45](#))).

1 Open object characteristics

- ▶ Start the application "HW Konfig"
- ▶ Click on AL1102.
- ▶ Select [Target System] > [Ethernet ...] > [Edit Ethernet Users].
- > [Edit Ethernet Users] window appears.

2 Search AL1102

- ▶ Click on [Durchsuchen ...] button.
- > [Browse Network] window appears.
- ▶ Click on [Start] button.
- > STEP 7 browses the Profinet network for devices.
- > List shows found devices.
- ▶ Select AL1102 in list and click [OK] to adopt the device.
- > The [MAC address] shows the MAC address of the AL1102

3 Set IP address and network mask

- ▶ Click on the [Use IP parameters] selection field in group [Set IP configuration].
- ▶ Enter the required IP address in the [IP address] field.
- ▶ Enter the required subnet mask in the [Subnet mask] field.

4 Assign device names

- ▶ Enter the required Profinet name in the [Device name] field.
- ▶ Click on the [Assign Name] button.
- > STEP 7 assigns the selected name to the AL1102.
- ▶ Click on the [Close] button to close the window.

8.5 Profinet: Configure IO-Link devices

18428

The AL1102 supports the configuration of the connected IO-Link devices out of the Profinet projection software. The configurable parameters depend on the corresponding IO-Link device.

Information about the usable functions: → **Profinet: Programmers' notes** (→ p. [50](#))



Available parameters of the IO-Link devices: → Operating instructions of the IO-Link device

8.6 Profinet: Programmers' notes

12761

The programmer can access on the following data from the PLC application:

- Read device information of the AL1102
- Read diagnostics and alarms
- Set parameters of the connected IO-Link devices



The following sections show the available options.



Further information about the functional/operational blocks: → Help function of the Profinet projection software

8.6.1 Read and write I&M datasets

2261

Symbol / function block	Meaning	Remarks
GET_IM_DATA / FB	Function block for reading the I&M datasets of a device  GET_IM_DATA only supports the reading of the I&M0 dataset	Input parameters: <ul style="list-style-type: none"> ▪ IM_TYPE = 0
RDREC	Function block for acyclic reading of datasets	Input parameters: <ul style="list-style-type: none"> ▪ I&M0: Index = 0xAFF0 ▪ I&M1: Index = 0xAFF1 ▪ I&M2: Index = 0xAFF2 ▪ I&M3: Index = 0xAFF3
WRREC	Function block for acyclic writing of datasets  Observe access rights on datasets!	Input parameters: <ul style="list-style-type: none"> ▪ I&M1: Index = 0xAFF1 ▪ I&M2: Index = 0xAFF2 ▪ I&M3: Index = 0xAFF3

8.6.2 Detect diagnostics and alarms

2272

Symbol / operational block	Meaning	Remarks
I/O_FLT1 / OB82	Diagnostic alarms	
I/O_FLT2 / OB83	Pull/plug in alarms	
RACK_FLT / OB86	Module rack failure	



Available alarms and diagnostic messages: → **Diagnostic and alarms** (→ p. [76](#))

8.6.3 Configure IO-Link devices

1860

Symbol / function block	Description	Remarks
IO_LINK_DEVICE / FB5001	Acyclic access to the parameters of an IO-Link device	Input parameters: <ul style="list-style-type: none"> ▪ CAP: Access point for function AL1102: 0xB400 ▪ PORT: HW-ID: Slot/sub-slot of the IO-Link port with connected IO-Link device Port X01: 1 Port X02: 2 Port X03: 3 Port X04: 4 Port X05: 5 Port X06: 6 Port X07: 7 Port X08: 8 ▪ IOL_INDEX and IOL_SUBINDEX: depends on the IO-Link device (→ operating instructions of the IO-Link device)
IOL_CALL / FB1	Acyclic access to the parameters of an IO-Link devices (obsolete)	→ IO_LINK_DEVICE

© ifm electronic gmbh



www.ifm.com

9 Operation

Contents	
Identify device.....	55
Read device information.....	55
Reboot the device.....	58
Error detection and elimination.....	58
Firmware update.....	59
Exchange IO-Link device.....	60

22368



9.1 Identify device

22816

In the online mode, the user can identify the device using the status LEDs RDY, BF und SF

- ▶ Start LR DEVICE.
- ▶ Scan network for devices.
- > LR DEVICE detects the device.
- ▶ Click on the selection field next to the device name.

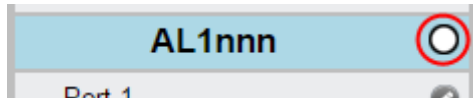

- > The status LEDs on the unit flash asynchronously.

9.2 Read device information

12741

In order to get information about the current status of the hardware and software components of the device, the user can use the following possibilities:

- **Web interface: Read device and diagnostic information** (→ p. [56](#))
- **LR DEVICE: Read device information** (→ p. [57](#))
- **Profinet: Read & write device information** (→ p. [57](#))

9.2.1 Web interface: Read device and diagnostic information

12744

In order to read the diagnostic information about the current device status via the web interface:

- ▶ Connect laptop/PC and AL1102 via the Ethernet internet.
- ▶ Start web browser.
- ▶ Enter the following into the address field of the browser: and confirm with [ENTER]:
<IP address of the device>
- > Web browser shows the web interface of the device.
- > The page shows the following data:
 - Table with connected IO-Link devices

Name	Description
[Port]	Number of the IO-Link interface
[Mode]	Operating mode of the IO-Link interface
[Comm. Mode]	Baud rate of the IO-Link interface
[MasterCycleTime]	Cycle time
[Vendor ID]	ID of the manufacturer of the IO-Link device
[Device ID]	ID of the IO-Link device
[Name]	Article number of the IO-Link device <ul style="list-style-type: none"> ▪ For ifm articles: This article number is stored along with a link to the produkt page on the ifm website.
[Serial]	Serial number of the IO-Link device
[LR Interval]	Cycle time for the communication with the SmartObserver

- Version information of the installed firmware components

Name	Description
[Firmware version]	Firmware version
[FirmwareCN Version]	Version of the firmware container
[Bootloader Version]	Version of the boot loader
[NETX Firmware Version]	Version of the Profinet firmware

- Diagnostic information of the device

Name	Description
[Current]	Current (in mA)
[Voltage]	Voltage (in mV)
[Short Circuit]	Number of detected short circuits
[Temperature]	Device temperature (in °C)



The page of the device is constantly updated. This is why the data is always up-to-date.

9.2.2 LR DEVICE: Read device information

11614

To show information about the AL1102:

- ▶ Start LR DEVICE.
- ▶ Scan network for devices.
- > LR DEVICE shows recognised AL1102.
- ▶ Mouse click on AL1102
- > The header shows the following information:

Name	Description	Possible values
Device name	Article number of the device	AL1102
Manufacturer	Manufacturer of the device	ifm electronic gmbh
Device ID	IO-Link ID of the device	
Serial number	Serial number of the device	
Revision	Hardware revision / software revision of the unit	
Type of unit	Name of the device	IO-Link master StandardLine Profinet 8 ports IP 65 / IP 67
Device status	Current status of the slave	<input type="checkbox"/> no information about the condition
		<input checked="" type="checkbox"/> OK: no errors, no warning, no information
		<input checked="" type="checkbox"/> OK: no errors, no warning, information
		<input checked="" type="checkbox"/> Warning
		<input checked="" type="checkbox"/> Error

9.2.3 Profinet: Read & write device information

22783

I&M0 provide the user with device-specific basic information. This ensures reliable identification of the device, the device's hardware and software components, and the manufacturer.

The datasets I&M1 to 3 offer the programmer the possibility to store project-specific information on the device.

The programmer can access the I&M0 datasets of the slots 0 and 1 in the Profinet projection software via the following functions:



Information about the usable function blocks: → **Profinet: Programmers' notes** (→ p. [50](#))

Further information about the I&M datasets: → **I&M datasets** (→ p. [75](#))

9.3 Reboot the device

12760

When restarting the device, all settings are kept.

To restart the AL1102:

- ▶ Start LR DEVICE.
- ▶ Scan the network for devices.
- > LR DEVICE recognises the AL1102.
- ▶ Under [ONLINE]: Click on [AL1102]
- ▶ Select the [Setup] section.
- > LR DEVICE shows available parameters.
- ▶ Click on [Restart] to restart the device.
- > LR DEVICE restarts the AL1102.

9.4 Error detection and elimination

11610

In order to recognise and eliminate errors, the user can use the following resource:

- Status LED of the unit (→ **LED indicators** (→ p. [24](#)))
- Acyclic alarms and diagnostic messages (→ **Diagnostic and alarms** (→ p. [76](#)))

9.5 Firmware update

22425

The new firmware is installed via the device's web interface.



If the firmware update is not successful, deactivate all connections to the Profinet PLC, LR SmartObserver and LR DEVICE and repeat the process.

- ▶ Stop Profinet PLC.
- ▶ Set the parameter [IP address SmartObserver] to 255.255.255.255 (→ **Configure the interface to the SmartObserver** (→ p. 36)).
- ▶ Stop the LRAgent.LRDevice service in the Windows task manager.

To install a new firmware version on the device:

Requirements

- > File with new firmware has been downloaded.
- > Ethernet connection between laptop/PC and device is established.

1 Call up web interface

- ▶ Start web browser.
- ▶ Enter the following into the address field of the browser: and confirm with [ENTER]:
<IP-Adresse des Geräts>/update
- > Web browser shows the [Firmware Update] page.

2 Load new firmware to AL1102

- ▶ Click on [Datei auswählen].
- > Dialogue window appears.
- ▶ Select the firmware file and click on [Öffnen] in order to adopt the file.
- ▶ Click on [Submit] to start the firmware update.
- > Firmware is being loaded to the device.
- > After successful storage, the success message is displayed

3 Restart the device

- ▶ Click on [Restart device now] to restart the device.
- > The status LED RDY flashes quickly.
- > Firmware is updating.
- ▶ Follow the instructions in the browser.

9.6 Exchange IO-Link device

7775

To exchange an IO-Link device:

Requirement:

- > IO-Link device is with factory settings.
- > IO-Link device supports IO-Link standard 1.1 or higher.

1 Set data storage

- ▶ Set the following parameters of the IO-Link port:
[Validation / Data Storage] = Type compatible V1.1 device with Restore
OR
[Port x IO-Link Validation / Data Storage] = Type compatible V1.1 device with Restore
- ▶ Save changes.

2 Exchange IO-Link device

- ▶ Disconnect old IO-Link device from AL1102.
- ▶ Connect new IO-Link device with the same IO-Link port of the AL1102.
- > IO-Link master copies parameter values from the data memory to the new IO-Link device.

10 Maintenance

21577

The operation of the unit is maintenance-free.

- ▶ Clean the surface of the unit when necessary. Do not use any caustic cleaning agents for this!
- ▶ After use, dispose of the unit in an environmentally friendly way in accordance with the applicable national regulations.



11 Factory settings

22671

In the factory settings, the device has the following parameter settings:

Parameters	Factory setting
[IP address]	0.0.0.0
[Subnet mask]	0.0.0.0
[IP gateway address]	0.0.0.0
[Profinet name]	blank
Data Storage	empty

12 Appendix

Contents

Technical data	64
Profinet	68

7156



12.1 Technical data

Contents	
Application	65
Electrical data	65
Inputs / outputs	65
Inputs	65
Outputs	65
Interfaces	66
Operating conditions	66
Approvals / tests	66
Mechanical data	67
Electrical connection	67

9011

12.1.1 Application

23710

Application	
Application	I/O modules for field applications
Daisy-chain function	Communication interface

12.1.2 Electrical data

22819

Electrical data	
Operating voltage	20...30 DC; (US; to SELV/PELV)
Current Consumption [mA]	300...3900; (US)
Protection class	III
Sensor supply US	
Max. current load total [A]	3.6

12.1.3 Inputs / outputs

23711

Inputs / outputs	
Total number of inputs and outputs	16; (configurable)

12.1.4 Inputs

22820

Inputs	
Number of digital inputs	16; (IO-Link Port Class A: 8 x 2)
Switching level high [V]	11...30 DC
Switching level low [V]	0...5 DC
Digital inputs protected against short circuits	yes

12.1.5 Outputs

22821

Outputs (digital)	
Output function	8; (IO-Link Port Class A: 8 x 1)
Max. current load per output [mA]	200
Short-circuit protection	yes

12.1.6 Interfaces

22822

Interfaces	
Communication interface	Ethernet; IO-Link
Communication interface	IO-Link; TCP/IP; PROFINET IO
Ethernet	
Transmission standard	10Base-T; 100Base-TX
Transmission rate	10; 100
Protocol	TCP/IP; PROFINET IO
Factory settings	<ul style="list-style-type: none"> ▪ IP address: 0.0.0.0 ▪ Subnet mask: 0.0.0.0 ▪ Gateway IP address: 0.0.0.0 ▪ MAC address: see type label
IO-Link Master	
Transmission type	COM 1 / COM 2 / COM 3
IO-Link revision	V1.1
Number of ports class A	8

12.1.7 Operating conditions

22823

Operating conditions	
Applications	Indoor use
Ambient temperature [°C]	-25...60
Storage temperature [°C]	-25...85
Max. perm. relative air humidity [%]	90
Max. height above sea level [m]	2000
Protection rating	IP 65; IP 67
Pollution Degree	2

12.1.8 Approvals / tests

22824

Approval / tests	
EMC	<ul style="list-style-type: none"> ▪ EN 61000-6-2 ▪ EN 61000-6-4
MTTF [Years]	90

12.1.9 Mechanical data

22825

Mechanical data	
Weight [g]	375
Materials	Housing: PA; socket: brass nickel-plated

12.1.10 Electrical connection

22826

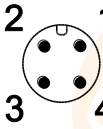
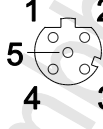
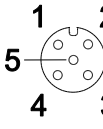
Voltage supply IN X31											
Connector	M12										
Wiring	 <table style="display: inline-table; vertical-align: middle;"> <tr> <td>1:</td> <td>+ 24 V DC (US)</td> </tr> <tr> <td>2:</td> <td>-</td> </tr> <tr> <td>3:</td> <td>GND (US)</td> </tr> <tr> <td>4:</td> <td>-</td> </tr> </table>	1:	+ 24 V DC (US)	2:	-	3:	GND (US)	4:	-		
1:	+ 24 V DC (US)										
2:	-										
3:	GND (US)										
4:	-										
Ethernet IN / OUT X21, X22											
Connector	M12										
Wiring	 <table style="display: inline-table; vertical-align: middle;"> <tr> <td>1:</td> <td>TX +</td> </tr> <tr> <td>2:</td> <td>RX +</td> </tr> <tr> <td>3:</td> <td>TX -</td> </tr> <tr> <td>4:</td> <td>RX -</td> </tr> <tr> <td>5:</td> <td>-</td> </tr> </table>	1:	TX +	2:	RX +	3:	TX -	4:	RX -	5:	-
1:	TX +										
2:	RX +										
3:	TX -										
4:	RX -										
5:	-										
Process connection IO-Link Ports Class A X01...X0<IOL_AnzPorts>											
Connector	M12										
Wiring	 <table style="display: inline-table; vertical-align: middle;"> <tr> <td>1:</td> <td>+ 24 V DC (US)</td> </tr> <tr> <td>2:</td> <td>DI</td> </tr> <tr> <td>3:</td> <td>GND (US)</td> </tr> <tr> <td>4:</td> <td>C/Q IO-Link</td> </tr> <tr> <td>5:</td> <td>-</td> </tr> </table>	1:	+ 24 V DC (US)	2:	DI	3:	GND (US)	4:	C/Q IO-Link	5:	-
1:	+ 24 V DC (US)										
2:	DI										
3:	GND (US)										
4:	C/Q IO-Link										
5:	-										

12.2 Profinet

Contents	
Parameter data	69
Cyclic data	72
Acyclic data	75

22433

12.2.1 Parameter data

1630

Slot	Subslot	Name	Description
1	1	Master	Parameter data of the IO-Link master (→ Parameter of the IO-Link master (→ p. 69))
	2	Port X01	<ul style="list-style-type: none"> ▪ Parameter data of the IO-Link ports (→ Parameters of the IO-Link ports (→ p. 70)) ▪ modules (→ Profinet modules (→ p. 73))
	3	Port X02	
	4	Port X03	
	5	Port X04	
	6	Port X05	
	7	Port X06	
	8	Port X07	
	9	Port X08	

Parameter of the IO-Link master

22788

Parameter	Description	Possible values	
[Access Rights]	The access rights to the parameter data, process data and events/diagnostic messages of the IO-Link master and the connected IO-Link devices	Profinet + LineRecorder	<ul style="list-style-type: none"> ▪ Profinet and LR DEVICE have read and write access rights to parameters and process data ▪ Profinet and LR DEVICE have read access rights to events/alarms
		Profinet + LineRecorder (ro)	<ul style="list-style-type: none"> ▪ Profinet has read and write access rights to parameters and process data ▪ Profinet has read access rights to events/alarms ▪ LR DEVICE only has read access rights to parameters, process data and events/alarms
		Profinet only	<ul style="list-style-type: none"> ▪ Profinet has read and write access rights to parameters and process data ▪ Profinet has read access rights to events/alarms ▪ LR DEVICE has no access rights (parameters, process data, events/alarms, web interface, firmware update)
		keep setting	keeps settings

Parameters of the IO-Link ports

22787

Parameter	Description	Possible values	
[Fail-safe mode]	Behaviour in case the Profinet connection is interrupted	No Fail Safe	deactivated
		Fail Safe Reset Value	reset to default values
		Fail Safe Old Value	maintain the most recent valid process value
		Fail Safe with Pattern	set user-defined values
[Pattern Value]*	<ul style="list-style-type: none"> required values for the process data in case the connection is interrupted (as hexadecimal value) Pattern depends on the size of the selected Profinet module 	Per byte: 0x00 ... 0xFF	
[Port cycle time]	Cycle time of the data transmission at the IO-Link port	as fast as possible	The device automatically sets the fastest possible cycle time
		2.0 ms ... 128.0 ms	2 milliseconds ... 128 milliseconds
[Validation / Data Storage]	Supported IO-Link standard and behaviour of the AL1102 when a new IO-Link device is connected to the IO-Link port	no check and clear	<ul style="list-style-type: none"> no verification of the vendor ID and device ID no data storage
		Type compatible V1.0 device	<ul style="list-style-type: none"> IO-Link device is compatible with the V1.0 IO-Link standard Verification whether it is an IO-Link device of the same type (validation via vendor ID and device ID) no data storage
		Type compatible V1.1 device	<ul style="list-style-type: none"> IO-Link device is compatible with the V1.1 IO-Link standard Verification whether it is an IO-Link device of the same type (validation via vendor ID and device ID) no data storage
		Type compatible V1.1 device with Backup + Restore	<ul style="list-style-type: none"> IO-Link device is compatible with the V1.1 IO-Link standard Verification whether it is an IO-Link device of the same type (validation via vendor ID and device ID) The IO-Link master saves the parameter values of the connected IO-Link device; modifications of the parameter values are also stored (→ observe the note!) When connecting an IO-Link device with factory settings, the parameter values stored in the IO-Link master are restored automatically on the IO-Link device.

Appendix

Parameter	Description	Possible values	
		Type compatible V1.1 device with Restore	<ul style="list-style-type: none"> ▪ IO-Link device is compatible with the V1.1 IO-Link standard ▪ Verification whether it is an IO-Link device of the same type (validation via vendor ID and device ID) ▪ The IO-Link master stores the parameter values of the connected IO-Link device once if the data memory of the AL1102 is empty. ▪ When connecting an IO-Link device with factory settings, the parameter values stored in the IO-Link master are restored automatically on the IO-Link device.
[Vendor ID (VID)]	ID of the manufacturer that is to be validated	0 ... 65535	ID of the manufacturer of the IO-Link device (ifm electronic: 310)
[Device ID]	ID of the IO-Link device that is to be validated	0 ... 16777215	ID of the IO-Link device

* ... settings are only valid if [Fail Safe Mode] = Fail Safe with Pattern



If the parameter values of an IO-Link device are changed with IO_LINK_DEVICE, the backup mechanism remains ineffective. The changed parameter values are not stored on the IO-Link master.

© ifm electronic gmbh

12.2.2 Cyclic data

Contents	
Profinet modules.....	73
PQI (Port Qualifier Information).....	74

22429



Profinet modules

22685

Module	Description	
IO-Link 32 I/ 32 O + PQI	IO-Link activated	32 bytes input and output data and PQI
IO-Link 16 I/ 16 O + PQI		16 bytes input and output data and PQI
IO-Link 8 I/ 8 O + PQI		8 bytes input and output data and PQI
IO-Link 4 I/ 4 O + PQI		4 bytes input and output data and PQI
IO-Link 2 I/ 2 O + PQI		2 bytes input and output data and PQI
IO-Link 1I/1O +PQI		1 byte input and output data and PQI
IO-Link 1I/15O +PQI		1 byte input and 15 bytes output data and PQI
IO-Link 32I +PQI		32 bytes input data and PQI
IO-Link 16I +PQI		16 bytes input data and PQI
IO-Link 8I +PQI		8 bytes input data and PQI
IO-Link 4I +PQI		4 bytes input data and PQI
IO-Link 2I +PQI		2 bytes input data and PQI
IO-Link 1I +PQI		1 bytes input data and PQI
IO-Link 32O +PQI		32 bytes output data and PQI
IO-Link 16O +PQI		16 bytes output data and PQI
IO-Link 8O +PQI		8 bytes output data and PQI
IO-Link 4O +PQI		4 bytes output data and PQI
IO-Link 2O +PQI		2 bytes output data and PQI
IO-Link 1O +PQI	1 bytes output data and PQI	
DI + PQI	IO-Link deactivated	Digital input and PQI
DO + PQI		Digital output and PQI
Disabled	deactivated	



PQI (Port Qualifier Information)

22686

Port Qualifier Information (PQI) contains diagnostic information about the IO-Link port. In addition to the process data, the IO-Link master sends the PQI to the Profinet controller.

Bit							
7	6	5	4	3	2	1	0
PQ	DE	DA	--	--	--	DI2	DI4

Legend:

DI4	Signal status of the digital input on Pin 4 (if used)	FALSE TRUE	= OFF = ON
DI2	Signal status of the digital input on Pin 2 (if used)	FALSE TRUE	= OFF = ON
DA	Device Available: shows if the IO-Link device has been recognised and if the device is in the "preoperate" or in the "operate" state	FALSE TRUE	= no device = device recognised
DE	Device Error: shows if an error or a warning occurred; Note: The user needs to determine the cause of the fault separately via acyclic services.	FALSE TRUE	= no error = error
PQ	Port Qualifier: shows if IO data is valid	FALSE TRUE	= invalid = valid

12.2.3 Acyclic data

22427

I&M datasets

22778

The AL1102 supports the following I&M datasets (I&M = Identification & Maintenance):

I&M0 (Slot 0)

22779

Variable	Description	Access*	Size
Vendor ID	IO-Link ID of the manufacturer	r	2
OrderID	Order number of the device (numbers are separated by blanks)	r	20
Serial number	Serial number of the device (numbers separated by blanks)	r	16
Hardware revision	Hardware revision of the device	r	2
Software revision prefix	Prefix of the software revision of the device (V, R, P, U or T)	r	1
Software Revision	Software revision (numbers separated by blanks, e.g. x y z in "Vx.y.z")	r	3
Revision Counter	Revision counter; is incremented with each parameter change	r	2
Profile ID	ID of sub-module profile (Slot 0: 0x0000)	r	2
Profile Specific Type	additional value for profile ID; 0, if not used	r	2
IMVersion	I&M version (default value: 0x0101)	r	2
IMSupported	Supported I&M datasets (0x1110 for I&M1-3)	r	2

* ... r = only read

I&M1 (Slot 0)

22765

Variable	Description	Access*	Size
TagFunction of submodule	function of the device (ASCII, padded with spaces)	r/w	32
TagLocation of submodule	Location of the device in the plant (ASCII, padded with spaces)	r/w	22

* ... r/w = read and write

I&M2 (Slot 0)

22780

Variable	Description	Access*	Size
Installation_Date	Installation date of the device (ASCII, padded with spaces)	r/w	16
	reserved	r/w	38

* ... r/w = read and write

Appendix

I&M3 (Slot 0)

22781

Variable	Description	Access*	Size
Descriptor	Description of the device (ASCII, padded with spaces)	r/w	54

* ... r/w = read and write

I&M0 (Slot 1)

22782

Variable	Description	Access*	Size
Vendor ID	IO-Link ID of the manufacturer	r	2
OrderID	Order number of the device (numbers are separated by blanks)	r	20
Serial number	Serial number of the device (numbers separated by blanks)	r	16
Hardware revision	Hardware revision of the device	r	2
Software revision prefix	Prefix of the software revision of the device (V, R, P, U or T)	r	1
SOFTWARE_REVISION	Software revision (numbers separated by blanks, e.g. x y z in "Vx.y.z")	r	3
REVISION_COUNTER	Revision counter; is incremented with each parameter change	r	2
Profile ID	ID of the sub-module profile (Slot 1: 0x4E01 = IO-Link)	r	2
Profile Specific Type	additional value for profile ID; 0, if not used	r	2
IMVersion	I&M version (default value: 0x0101)	r	2
IMSupported	Supported I&M datasets (0x0E for I&M1-3)	r	2

* ... r = only read

Diagnostic and alarms

22784

ECD code	Name	Description	Type
0x02	EVNT_CODE_M_PDU_CHECK	Receive frame with CRC error	Alarm
0x1B	EVNT_CODE_S_RETRY	Repetitions detected	Alarm
0x1E	EVNT_CODE_P_SHORT	Short circuit on C/Q cable detected	Diagnostics
0x1F	EVNT_CODE_P_SENSOR	Error in the sensor supply	Diagnostics
0x20	EVNT_CODE_P_ACTOR	Error in the actuator supply	Diagnostics
0x21	EVNT_CODE_P_POWER	Error in the power supply of the IO-Link master	Diagnostics
0x28	EVNT_CODE_DSREADY_NOACTION	Data storage completed, but no action, since CRC was correct	Alarm
0x29	DS_FAULT_IDENT	Sensor does not match the content of the data memory	Alarm
0x2A	DS_FAULT_SIZE	Sensor parameters too large for data memory	Alarm
0x2B	DS_FAULT_UPLOAD	Error during data memory transmission from the sensor	Alarm
0x2C	DS_FAULT_DOWNLOAD	Error during data memory transmission to the sensor	Alarm
0x2F	DS_FAULT_DEVICE_LOCKED	Error during data storage because the device is blocked	Alarm
0x32	EVNT_CODES_DSREADY_DOWNLOAD	Parameter transmission to the sensor finished	Alarm
0x33	EVNT_CODE_DSREADY_UPLOAD	Parameter transmission from the sensor finished	Diagnostics

13 Index

A

Acyclic data75
 Add the device to the Profinet network.....45
 Appendix63
 Application65
 Approvals / tests66

C

CAN standard units.....51
 Command channel.....38
 Communication, parameter setting, evaluation.....13
 Configuration26
 Configure communication profile.....34, 47
 Configure IO-Link devices52
 Configure the Ethernet interface35
 Configure the interface to the SmartObserver36
 Configure the Profinet interface.....49
 Connect the device.....21
 Connection possibilities.....28
 Cyclic data72

D

Detect diagnostics and alarms51
 Diagnostic and alarms76
 Digital inputs15

E

Electrical connection17, 67
 Electrical data65
 Error detection and elimination.....58
 Ethernet interface24
 Ethernet ports18
 Exchange IO-Link device.....60

F

Factory settings62
 Firmware update.....59
 Function12
 Functions and features11

G

General.....9

I

I&M datasets75
 I&M0 (Slot 0).....75
 I&M0 (Slot 1).....76
 I&M1 (Slot 0).....75
 I&M2 (Slot 0).....75
 I&M3 (Slot 0).....76
 Identify device.....55
 ifm weltweit • ifm worldwide • ifm à l'échelle internationale.....79
 Input circuit19
 Inputs65
 Inputs / outputs65

Install GSD file44
 Interfaces66
 IO-Link14
 IO-Link circuits20
 IO-Link ports19
 IO-Link ports (Class A)25
 IO-Link supply15
 IO-Link-Ports konfigurieren.....48

L

LED indicators24
 Legal and copyright information6
 LR DEVICE
 Configure IO-Link devices.....41
 Configure the device32
 Read device information57

M

Maintenance61
 Mechanical data67
 Modification history.....7
 Mount the device16
 Mounting16

O

Offline parameter setting31
 Add IO-Link devices manually42
 Operating and display elements.....22
 Operating conditions.....66
 Operation54
 Operation with Profinet connection (without LR DEVICE)29
 Operation with Profinet connection and LR DEVICE/LR SmartObserver30
 Operation without Profinet connection28
 Outputs65
 Overview23

P

Parameter data69
 Parameter of the IO-Link master69
 Parameter setting14
 Parameters of the IO-Link ports70
 Permitted use.....11
 PI controller.....6
 PQI (Port Qualifier Information).....74
 Preliminary note.....5
 Profinet.....14, 68
 Configure IO-Link devices.....50
 Configure the device43
 Programmers' notes50
 Read & write device information57

Profinet modules73
 Prohibited use11
 Purpose of the document6

R

Read and write I&M datasets51
 Read device information.....55
 Reboot the device.....58
 Remarks.....27

Index

Required background knowledge9
 Reset IO-Link master to factory settings40

S

Safety instructions8
 Safety symbols on the device10
 Set device validation and data storage38
 Set the operating mode of the IO-Link ports37
 Set-up33
 Status LEDs24
 Supported configuration options28
 Symbols and styles used6

T

Tampering with the unit10
 Technical data64

V

Visual indication14
 Voltage supply25
 VPN connection31

W

Warnings used9
 Web interface
 Read device and diagnostic information56

© ifm electronic gmbh



www.ifm.com

14 ifm weltweit • ifm worldwide • ifm à l'échelle internationale

Version: 2016-11-29

8310

ifm electronic gmbh • Friedrichstraße 1 • 45128 Essen

www.ifm.com • Email: info@ifm.com

Service hotline: 0800 / 16 16 16 (only Germany, Mo-Fr 07.00...18.00 h)

ifm Niederlassungen • Sales offices • Agences

D	Niederlassung Nord • 31135 Hildesheim • Tel. 0 51 21 / 76 67-0 Niederlassung West • 45128 Essen • Tel. 02 01 / 3 64 75 -0 Niederlassung Mitte-West • 58511 Lüdenscheid • Tel. 0 23 51 / 43 01-0 Niederlassung Süd-West • 64646 Heppenheim • Tel. 0 62 52 / 79 05-0 Niederlassung Baden-Württemberg • 73230 Kirchheim • Tel. 0 70 21 / 80 86-0 Niederlassung Bayern • 82178 Puchheim • Tel. 0 89 / 8 00 91-0 Niederlassung Ost • 07639 Tautenhain • Tel. 0 36 601 / 771-0
A, SL	ifm electronic gmbh • 1120 Wien • Tel. +43 16 17 45 00
AUS	ifm efector pty ltd. • Mulgrave Vic 3170 • Tel. +61 3 00 365 088
B, L	ifm electronic N.V. • 1731 Zellik • Tel. +32 2 / 4 81 02 20
BG	ifm electronic eood • 1202 Sofia • Tel. +359 2 807 59 69
BR	ifm electronic Ltda. • 03337-000, Sao Paulo SP • Tel. +55 11 / 2672-1730
CH	ifm electronic ag • 4 624 Härkingen • Tel. +41 62 / 388 80 30
CL	ifm electronic SpA • Oficina 5032 Comuna de Conchalí • Tel. +55 11 / 2672-1730
CN	ifm electronic (Shanghai) Co. Ltd. • 201203 Shanghai • Tel. +86 21 / 3813 4800
CND	ifm efector Canada inc. • Oakville, Ontario L6K 3V3 • Tel. +1 800-441-8246
CZ	ifm electronic spol. s.r.o. • 25243 Průhonice • Tel. +420 267 990 211
DK	ifm electronic a/s • 2605 BROENDBY • Tel. +45 70 20 11 08
E	ifm electronic s.a. • 08820 El Prat de Llobregat • Tel. +34 93 479 30 80
F	ifm electronic s.a. • 93192 Noisy-le-Grand Cedex • Tél. +33 0820 22 30 01
FIN	ifm electronic oy • 00440 Helsinki • Tel. +358 75 329 5000
GB, IRL	ifm electronic Ltd. • Hampton, Middlesex TW12 2HD • Tel. +44 208 / 213-0000
GR	ifm electronic Monoprosopi E.P.E. • 15125 Amaroussio • Tel. +30 210 / 6180090
H	ifm electronic kft. • 9028 Győr • Tel. +36 96 / 518-397
I	ifm electronic s.a. • 20041 Agrate-Brianza (MI) • Tel. +39 039 / 68.99.982
IL	Astragal Ltd. • Azur 58001 • Tel. +972 3 -559 1660
IND	ifm electronic India Branch Office • Kolhapur, 416234 • Tel. +91 231-267 27 70
J	efector co., ltd. • Chiba-shi, Chiba 261-7118 • Tel. +81 043-299-2070
MAL	ifm electronic Pte. Ltd • 47100 Puchong Selangor • Tel. +603 8063 9522
MEX	ifm efector S. de R. L. de C. V. • Monterrey, N. L. 64630 • Tel. +52 81 8040-3535
N	Sivilingeniør J. F. Knudtzen A/S • 1396 Billingstad • Tel. +47 66 / 98 33 50
NA	ifm electronic (pty) Ltd • 25 Dr. W. Kulz Street Windhoek • Tel. +264 61 300984
NL	ifm electronic b.v. • 3843 GA Harderwijk • Tel. +31 341 / 438 438
NZ	ifm efector pty ltd • 930 Great South Road Penrose, Auckland • Tel. +64 95 79 69 91
P	ifm electronic s.a. • 4410-136 São Félix da Marinha • Tel. +351 223 / 71 71 08
PL	ifm electronic Sp. z o.o. • 40-106 Katowice • Tel. +48 32-608 74 54
RA, ROU	ifm electronic s.r.l. • 1107 Buenos Aires • Tel. +54 11 / 5353 3436
RO	ifm electronic s.r.l. • Sibiu 557260 • Tel. +40 269 224550
ROK	ifm electronic Ltd. • 140-884 Seoul • Tel. +82 2 / 790 5610
RUS	ifm electronic • 105318 Moscow • Tel. +7 495 921-44-14
S	ifm electronic a b • 41250 Göteborg • Tel. +46 31 / 750 23 00
SGP	ifm electronic Pte. Ltd. • Singapore 609 916 • Tel. +65 6562 8661/2/3
SK	ifm electronic s.r.o. • 835 54 Bratislava • Tel. +421 2 / 44 87 23 29
THA	SCM Alliance Co., Ltd. • Bangkok 10 400 • Tel. +66 02 615 4888
TR	ifm electronic Ltd. Sti. • 34381 Sisli/Istanbul • Tel. +90 212 / 210 50 80
UA	TOV ifm electronic • 02660 Kiev • Tel. +380 44 501 8543
USA	ifm efector inc. • Exton, PA 19341 • Tel. +1 610 / 5 24-2000
VN	ifm electronic • Ho Chi Minh city 700000 • Tel. +84-8-35125177
ZA	ifm electronic (Pty) Ltd. • 0157 Pretoria • Tel. +27 12 345 44 49

Technische Änderungen behalten wir uns ohne vorherige Ankündigung vor.

We reserve the right to make technical alterations without prior notice.

Nous nous réservons le droit de modifier les données techniques sans préavis.

