

Instructions for set-up

Electric motor
Application package

UK



1 Contents

1 Preliminary note	3
1.1 Symbols used	3
1.2 Further documents	3
2 Safety instructions	4
3 Functions and features	4
4 System requirements	4
5 Function	4
5.1 Diagnostic unit VSE100	5
6 Installation.	5
6.1 Sensors	5
6.2 Diagnostic unit VSE100	6
6.3 Power supply	6
6.4 5-segment light tower DV1500 (optional)	6
7 Electrical connection.	7
8 Set-up	8
8.1 Install and start the APA set-up software	8
8.2 Display current measured values of the parameters	9
8.3 Configure parameters.	9
9 Operation	9
9.1 Monitoring via the 5-segment light tower	9

1 Preliminary note

 You will find detailed instructions, technical data, approvals and further information using the QR code on the individual units / packagings or at www.ifm.com.

1.1 Symbols used

- ▶ Instruction
- > Reaction, result
- [...] Designation of keys, buttons or indications
- Cross-reference
-  Important note
Non-compliance may result in malfunction or interference.
-  Information
Supplementary note.

1.2 Further documents

- installation instructions
- operating instructions
- software manual

 The documents can be downloaded at: www.ifm.com

2 Safety instructions

- The devices described are integrated into a system as components.
 - The system architect is responsible for the safety of the system.
 - The system architect undertakes to perform a risk assessment and to create documentation in accordance with legal and normative requirements to be provided to the operator and user of the system. This documentation must contain all necessary information and safety instructions for the operator, the user and, if applicable, for any service personnel authorised by the architect of the system.
 - The system architect is responsible for the proper functioning of the application programs.
- Read this document before setting up the product and keep it during the entire service life.
- The product must be suitable for the corresponding applications and environmental conditions without any restrictions.
- Only use the product for its intended purpose (→ 3 Functions and features).
- If the operating instructions or the technical data are not adhered to, personal injury and/or damage to property may occur.
- The manufacturer assumes no liability or warranty for any consequences caused by tampering with the product or incorrect use by the operator.
- Installation, electrical connection, set-up, operation and maintenance of the product must be carried out by qualified personnel authorised by the machine operator.
- Protect units and cables against damage.

3 Functions and features

Vibration diagnostics and condition monitoring of electric motors in accordance with the chosen application (application environment, rotational speed etc.).

4 System requirements

Installation of the Application Package Assistant (APA) software for starting up a diagnostic unit requires a PC. For the system requirements please refer to the Application Package Assistant (APA) software manual.

5 Function

The electric motor application is used for permanent monitoring of electric motors and allows for condition-based system maintenance. Via the detection and evaluation of the temperature, rotational speed and vibrations of the motor, continuous diagnostics is provided with regard to the following failure causes:

- unbalance
- wear
- overall vibration
- bearing damage
- winding failures
- dirt in the motor

Depending on the application that you have chosen (application environment, rotational speed etc.), you will receive the respective parameter set for configuration of the diagnostic unit (VSE100). In order to transfer the parameter set to the VSE100 unit, you only require a PC and the Application Package Assistant (APA) software.

The following illustration shows an example set-up of an electric motor application:

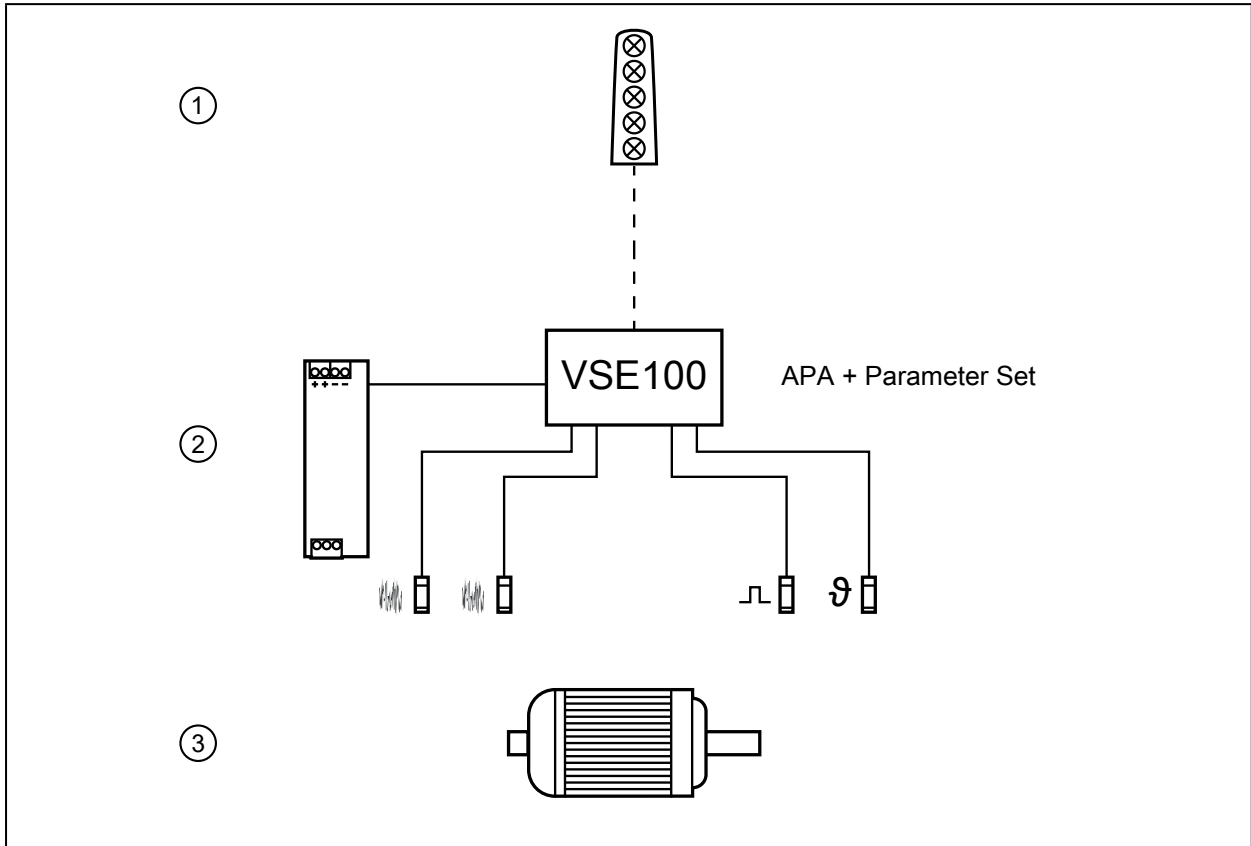

- 1: 5-segment light tower (optional)
 2: electric motor application - application package
 3: not included in scope of supply, individual equipment / devices

5.1 Diagnostic unit VSE100

The diagnostic unit serves as an evaluation unit for the process data of the connected sensors. The VSE100 unit can be configured via the APA software.

6 Installation

- !** ► Disconnect the power of the machine before installation.

Adhere to the instructions enclosed to the individual devices.

6.1 Sensors

- Install the vibration sensors as close as possible to the bearing.
- Install the temperature sensor flat on the motor in order to enable precise temperature measurement.

► Install the inductive sensor.

 The inductive sensor is used for rotational speed monitoring. This requires that a screw is fixed on the shaft. The screw head serves as the switching cam. Another option is to attach a small metal plate at a suitable position on the motor (e.g. on the fan blade). The inductive sensor has to be fixed in a way that allows for it to be damped by the screw or the small metal plate.

It is recommended to compensate for the additional weight by removing an equivalent amount of weight.

 Tighten all sensors with the indicated tightening torque.

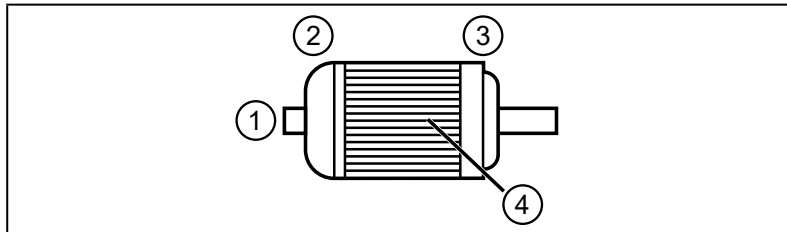

Positioning

- 1: inductive sensor for rotational speed detection
- 2: vibration sensor (motor, non drive end)
- 3: vibration sensor (motor, drive end)
- 4: temperature sensor

6.2 Diagnostic unit VSE100

Mount the unit in a control cabinet with a protection rating of at least IP 54 to ensure protection against accidental contact with dangerous contact voltages and against atmospheric influence. The control cabinet should be installed in accordance with local and national rules and regulations.

Mount the unit on a DIN rail. Mount it vertically and leave enough space between the unit and the top and bottom of the control cabinet (to enable air circulation to avoid excessive heating).

 Suited for DIN rails according to EN 60715 with a height of 7.5 or 15 mm.

At maximum ambient temperature, additional convection cooling is necessary.

Prevent the penetration of conductive or other dirt during installation and wiring.

6.3 Power supply

► Install the power supply in the control cabinet, taking into account the following:

- Suited for DIN rails according to EN 60715 with a height of 7.5 or 15 mm.
- The input terminals are located on the lower front part of the device.
- Adhere to the following installation distances under permanent full load operation: Left / right: 5 mm (15 mm in case of neighbouring heat sources)
Top: 40 mm, bottom: 20 mm from the device.

 The device is designed for convection cooling.

- The air circulation must not be impeded. Adhere to the installation distances.

6.4 5-segment light tower DV1500 (optional)

 ► For installation choose a flat mounting surface.

More information about available accessories at www.ifm.com

7 Electrical connection



The devices must be connected by a qualified electrician.

- ▶ Observe the national and international regulations for the installation of electrical equipment.
- ▶ Adhere to the instructions enclosed to the individual devices.
- ▶ Disconnect power.

- ▶ Connect the sensors (vibration, speed and temperature) to the VSE100 unit.
- ▶ Connect the VSE100 unit to the secondary side of the power supply.
- ▶ Connect the 5-segment light tower to the diagnostic unit (optional).
- ▶ Connect the primary side of the power supply unit to the voltage supply.



The 5-segment light tower has been preconfigured for the wiring illustrated below and is ready for operation.

For special configurations observe the device's operating instructions.

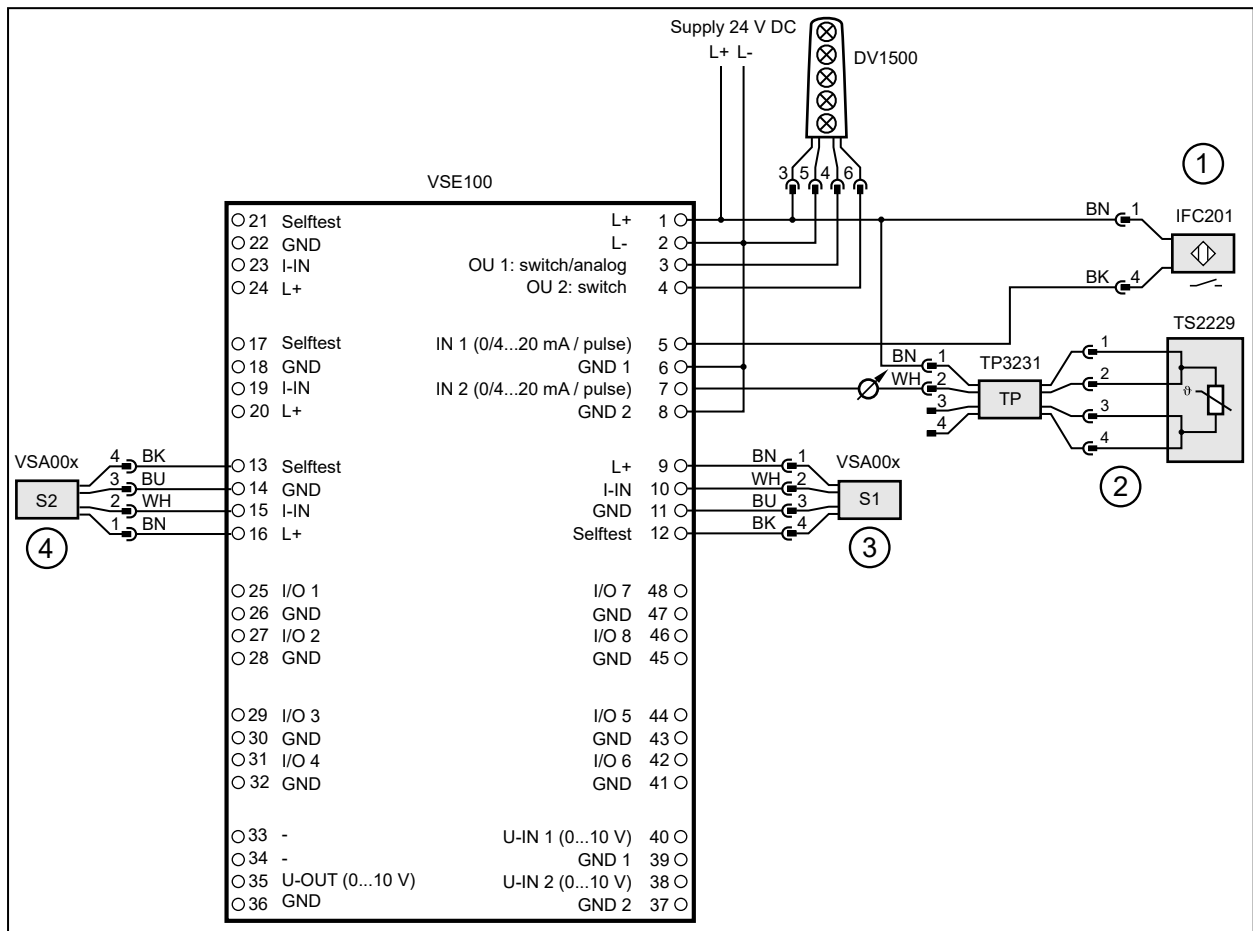

- 1: inductive sensor for rotational speed detection
- 2: temperature sensor with evaluation electronics
- 3: vibration sensor (motor, non drive end)
- 4: vibration sensor (motor, drive end)

8 Set-up

The diagnostic unit has 2 analogue inputs and 4 dynamic inputs. These inputs can be used for process value monitoring, vibration monitoring, vibration diagnostics or analysis of other dynamic signals. The actual function depends on the firmware version. The current firmware and operating software can be downloaded from the download area on ifm electronic's website.



All required electric motor application components must be correctly connected to each other and be powered.

8.1 Install and start the APA set-up software



Installation of the APA software does not require any administrator rights.



▶ The parameter set (ipar file) provided by ifm is only compatible with software version APA V2.00.02 or higher.

- ▶ Connect the VSE100 unit via a network cable to a PC.
- ▶ Save the parameter set (ipar file), provided by ifm, on the PC.
- ▶ Unpack the downloaded ZIP file on a local data carrier.

The APA software runs directly in the unzipped installation folder. In order to start the APA software:

- ▶ Open the installation folder.
- ▶ Double-click on "APA.exe".



On delivery, the VSE100 unit has the following configuration:

IP address	192.168.0.1
Subnet mask	255.255.255.0

The PC's IP address must be in the same subnet (e.g. 192.168.0.10).

- ▶ Click the [+] button in the window [Select application].
- > The window [New application] appears.
- ▶ Click the [Select] button in the [Select file] section.
- ▶ Select the parameter set (ipar file) which you have saved and click on [Open].
- > Application information from the parameter file is displayed in an overview.
- ▶ Check application.
- ▶ If the application is OK, click the [>] button, otherwise open another parameter file.
- > [Select device] appears.
- > The program searches for devices in the network and shows the found devices in a table.
- ▶ Select device and click the [>] button.
- > Connecting to device.
- > Write the parameters from the parameter file to the device.
- > Display [Done] when the writing process is finished.
- ▶ Close the window by clicking [✓].

8.2 Display current measured values of the parameters

- ▶ Click [Configuration].
- > The live status and the measured values of the parameters are displayed under [Value] in the table.

! Process-related interfering signals may affect vibration diagnostics. If the diagnostic values vary considerably, it is recommended to reduce the monitoring range or the spectrum of the diagnosis objects.

The bearing diagnostic values can also be affected by various factors (such as special plant configurations, start-up and switch-off cycles when running in resonant ranges, process-related factors during operation). If the diagnostic values are heavily affected, a reference movement is recommended for the bearing diagnostics.

UK

8.3 Configure parameters





Depending on the application, limit values may have to be adapted.

- ▶ Click [Configuration].
- ▶ Click [Edit parameters].
- ▶ Enter / set limit values for warning alarm and damage alarm and confirm with [Enter].
- ▶ Click [Write to device].
- > Changed parameter values are active in the device.

9 Operation

9.1 Monitoring via the 5-segment light tower

It is also possible to visually signal alarms by means of the 5-segment light tower DV1500 (optional).

	Segment 1: damage alarm
	Segment 2: warning alarm
	Segment 3: operating voltage
	Segment 4: -
	Segment 5: -

i For more detailed explanations we refer you to the operating instructions of the 5-segment light tower and to ifm.com.