

Instructions for set-up

Pump application
Application solution

UK



Contents

1	Preliminary note	3
1.1	Symbols used	3
1.2	Further documents	3
2	Safety instructions	4
3	Functions and features	4
4	Function	4
4.1	Diagnostic unit VSE100	5
4.2	Appliance	5
5	Installation	6
5.1	Sensors	6
5.1.1	Centrifugal pump, pump on the motor shaft	6
5.1.2	Centrifugal pump with a single bearing on the pump shaft	6
5.1.3	Centrifugal pump with dual bearings on the pump shaft	7
5.2	Diagnostic unit VSE100	7
5.3	Power supply	7
5.4	Appliance (pre-configured industrial PC)	7
5.5	5-segment light tower DV1500 (optional)	8
6	Electrical connection	8
6.1	Wiring diagram appliance	9
7	Set-up	10
7.1	Setting up the appliance	10
7.1.1	Option 1: local access	10
7.1.2	Option 2: remote access	10
7.2	Create a backup copy of the operating system	11
7.3	Select a parameter set	11
7.4	Start the APA set-up software	11
7.5	Configure a new application	12
7.6	Display current measured values of the parameters	12
7.7	Configure parameters	12
8	Operation	13
8.1	Monitor process data	13
8.2	Monitoring via the 5-segment light tower	14

1 Preliminary note

 You will find detailed instructions, technical data, approvals and further information using the QR code on the individual units / packagings or at www.ifm.com.

1.1 Symbols used

- ▶ Instruction
- > Reaction, result
- [...] Designation of keys, buttons or indications
- Cross-reference
-  Important note
Non-compliance may result in malfunction or interference.
-  Information
Supplementary note.

1.2 Further documents

- installation instructions
- operating instructions
- software manual

 The documents can be downloaded at: www.ifm.com

2 Safety instructions

- The devices described are integrated into a system as components.
 - The system architect is responsible for the safety of the system.
 - The system architect undertakes to perform a risk assessment and to create documentation in accordance with legal and normative requirements to be provided to the operator and user of the system. This documentation must contain all necessary information and safety instructions for the operator, the user and, if applicable, for any service personnel authorised by the architect of the system.
 - The system architect is responsible for the proper functioning of the application programs.
- Read this document before setting up the product and keep it during the entire service life.
- The product must be suitable for the corresponding applications and environmental conditions without any restrictions.
- Only use the product for its intended purpose (→ 3 Functions and features).
- If the operating instructions or the technical data are not adhered to, personal injury and/or damage to property may occur.
- The manufacturer assumes no liability or warranty for any consequences caused by tampering with the product or incorrect use by the operator.
- Installation, electrical connection, set-up, operation and maintenance of the product must be carried out by qualified personnel authorised by the machine operator.
- Protect units and cables against damage.

3 Functions and features

Vibration diagnostics and condition monitoring of centrifugal pumps in accordance with the chosen application (pump type, rotational speed etc.).

4 Function

The pump application is used for permanent monitoring of pumps and allows for condition-based system maintenance. Via the detection and evaluation of the motor's temperature and rotational speed and of vibration on pump and motor, continuous diagnostics is provided with regard to the following failure causes:

- unbalance
- wear
- contamination
- overall vibration
- bearing damage
- cavitation

Depending on the application that you have chosen (pump type, rotational speed etc.), you will receive the respective parameter set for configuration of the diagnostic unit (VSE100). In order to transfer the parameter set to the VSE100 unit, you only require a PC and the Application Package Assistant (APA) software.

The pre-installed software LR SMARTOBSERVER provides the following functions:

- visualisation of process values
- analysis of process data with different evaluation and display options
- alarm system

The following illustration shows an example set-up of a pump application:

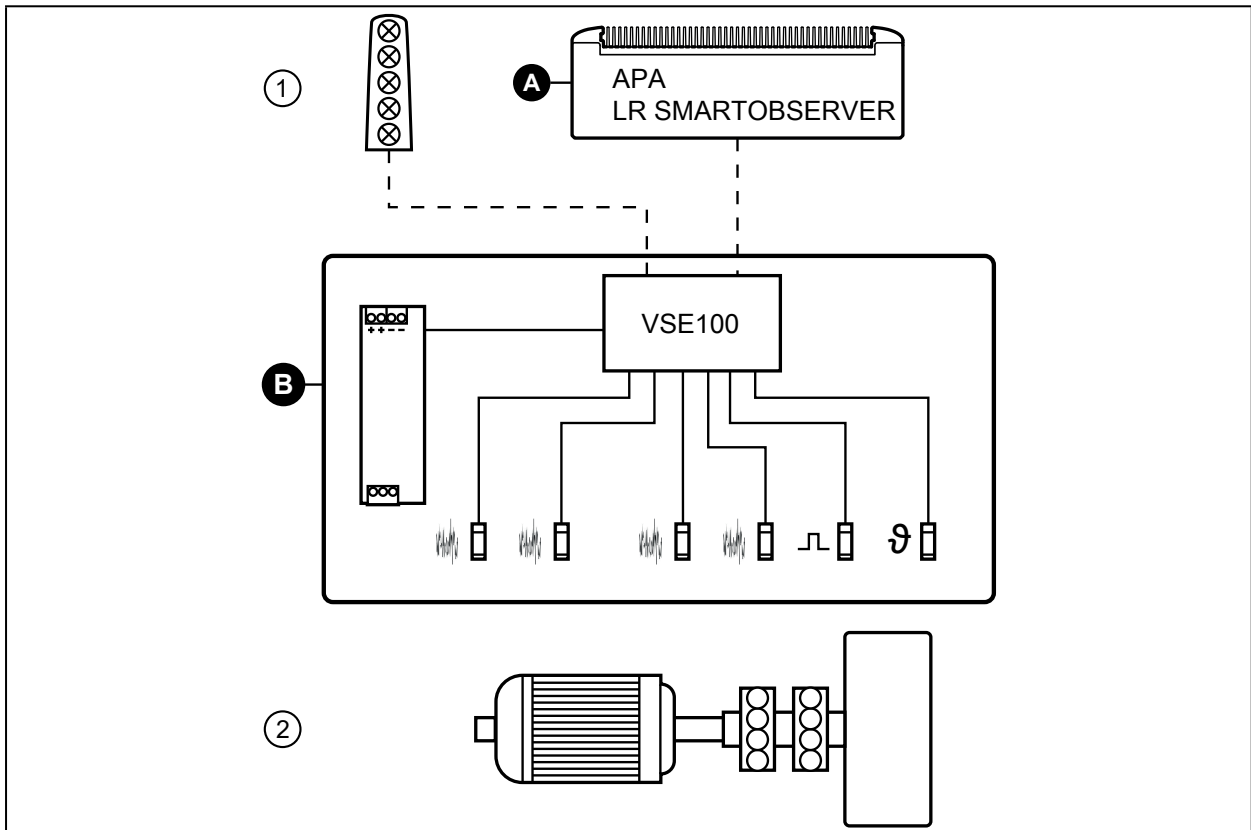

Fig. 1: application solution overview

A: Appliance

B: application package consisting of:

- power supply
- diagnostic unit VSE100
- vibration sensors
- temperature sensor
- inductive sensor

1: 5-segment light tower (optional)

2: not included in scope of supply, individual equipment / devices

4.1 Diagnostic unit VSE100

The diagnostic unit serves as an evaluation unit for the process data of the connected sensors. The VSE100 unit can be configured via the APA software.

4.2 Appliance

The appliance offers the following functions:

- parameter setting of the diagnostic unit VSE100 and of the connected sensors via APA
- monitoring of the process data via LR SMARTOBSERVER

5 Installation

! ▶ Disconnect the power of the machine before installation.

Adhere to the instructions enclosed to the individual devices.

5.1 Sensors

- ▶ Install the vibration sensors as close as possible to the bearing.
- ▶ Install the temperature sensor flat on the motor in order to enable precise temperature measurement.
- ▶ Install the inductive sensor.

i The inductive sensor is used for rotational speed monitoring. This requires that a screw is fixed on the shaft. The screw head serves as the switching cam. Another option is to attach a small metal plate at a suitable position on the motor of the pump (e.g. on the fan blade). The inductive sensor has to be fixed in a way that allows for it to be damped by the screw or the small metal plate.

It is recommended to compensate for the additional weight by removing an equivalent amount of weight.

i Tighten all sensors with the indicated tightening torque.

Sensor positioning depends on the pump type.

5.1.1 Centrifugal pump, pump on the motor shaft

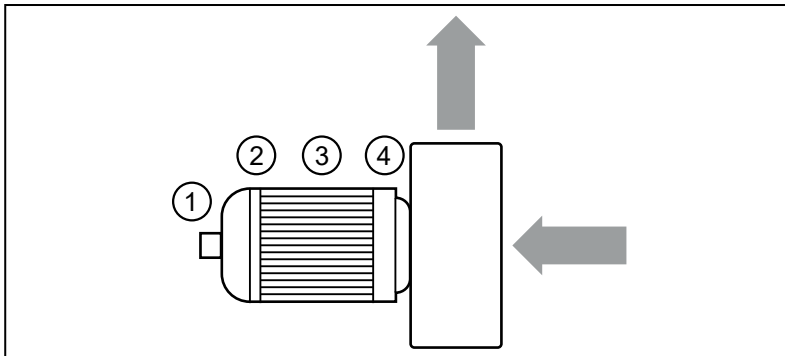

Positioning

- 1: inductive sensor for rotational speed detection
- 2: vibration sensor (motor, non drive end)
- 3: temperature sensor
- 4: vibration sensor (motor, drive end)

5.1.2 Centrifugal pump with a single bearing on the pump shaft

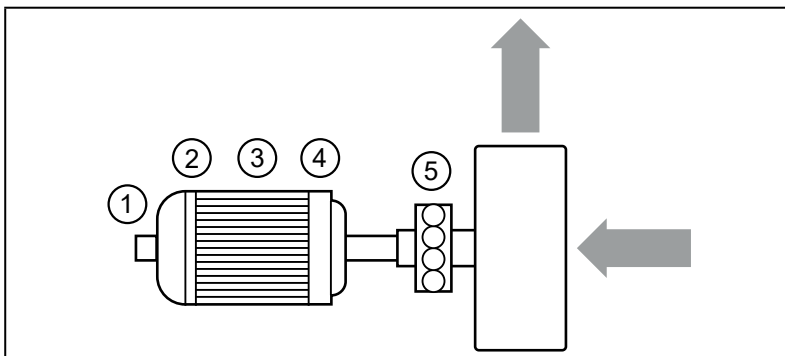

Positioning

- 1: inductive sensor for rotational speed detection
- 2: vibration sensor (motor, non drive end)
- 3: temperature sensor
- 4: vibration sensor (motor, drive end)
- 5: vibration sensor (pump, drive end)

5.1.3 Centrifugal pump with dual bearings on the pump shaft

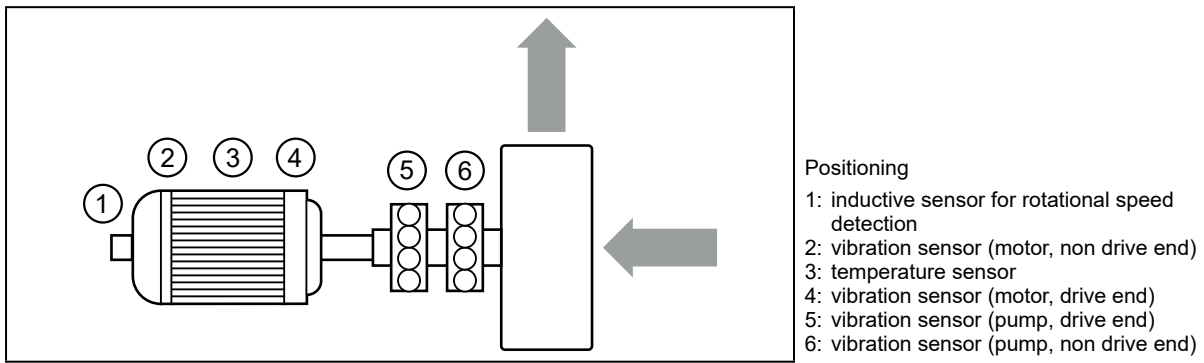

5.2 Diagnostic unit VSE100

Mount the unit in a control cabinet with a protection rating of at least IP 54 to ensure protection against accidental contact with dangerous contact voltages and against atmospheric influence. The control cabinet should be installed in accordance with local and national rules and regulations.

Mount the unit on a DIN rail. Mount it vertically and leave enough space between the unit and the top and bottom of the control cabinet (to enable air circulation to avoid excessive heating).

 Suited for DIN rails according to EN 60715 with a height of 7.5 or 15 mm.

At maximum ambient temperature, additional convection cooling is necessary.

Prevent the penetration of conductive or other dirt during installation and wiring.

5.3 Power supply

- ▶ Install the power supply in the control cabinet, taking into account the following:
 - Suited for DIN rails according to EN 60715 with a height of 7.5 or 15 mm.
 - The input terminals are located on the lower front part of the device.
 - Adhere to the following installation distances under permanent full load operation: Left / right: 5 mm (15 mm for adjacent heat sources)
Top: 40 mm, bottom: 20 mm from the device.

-  The device is designed for convection cooling.
 - ▶ The air circulation must not be impeded. Adhere to the installation distances.

5.4 Appliance (pre-configured industrial PC)

- ▶ Install the device in the control cabinet, taking into account the following:
 - Mount the device on a flat surface.
 - Use 4 M5 mounting screws and washers for fastening.

-  The device is designed for convection cooling.
 - ▶ The air circulation must not be impeded. Adhere to the installation distances.

5.5 5-segment light tower DV1500 (optional)

- ▶  For installation choose a flat mounting surface.

More information about available accessories at www.ifm.com

6 Electrical connection

- ▶  The devices must be connected by a qualified electrician.
 - ▶ Observe the national and international regulations for the installation of electrical equipment.
 - ▶ Adhere to the instructions enclosed to the individual devices.
 - ▶ Disconnect power.
- ▶ Connect the sensors (vibration, speed and temperature) to the VSE100 unit.
- ▶ Connect the VSE100 unit to the secondary side of the power supply.
- ▶ Connect the VSE100 unit via Ethernet interface to Ethernet interface 1 of the appliance (industrial PC).
- ▶ Connect the 5-segment light tower to the diagnostic unit (optional).
- ▶ Connect the appliance (industrial PC) to the secondary side of the power supply.
- ▶ Connect the primary side of the power supply unit to the voltage supply.

- ▶  The 5-segment light tower has been preconfigured for the wiring illustrated below and is ready for operation.

For special configurations observe the device's operating instructions.

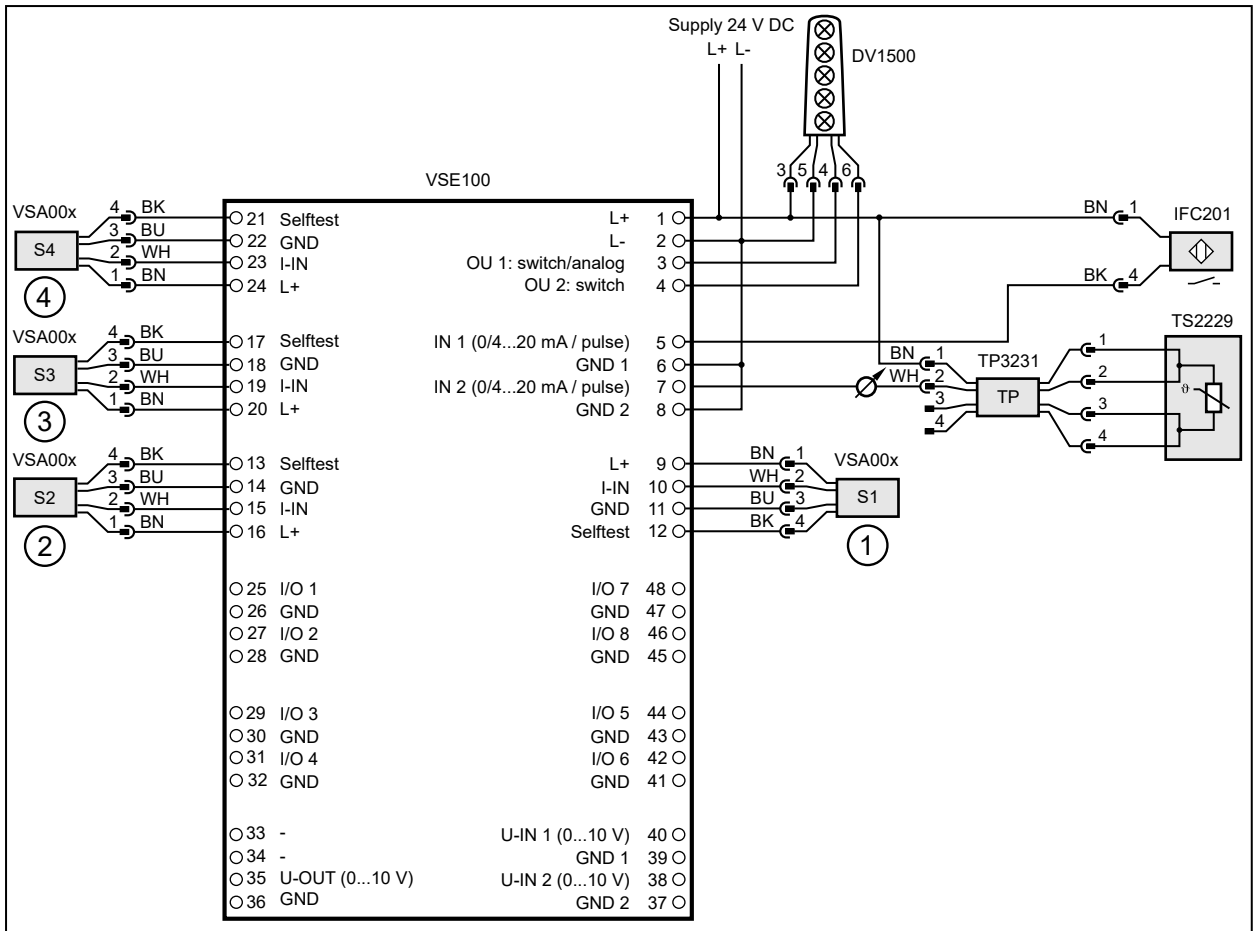

- 1: vibration sensor (motor, non drive end)
- 2: vibration sensor (motor, drive end)
- 3: vibration sensor (pump, drive end)
- 4: vibration sensor (pump, non drive end)

S3 and S4 only for centrifugal pumps with a single bearing or dual bearings on the pump shaft

6.1 Wiring diagram appliance

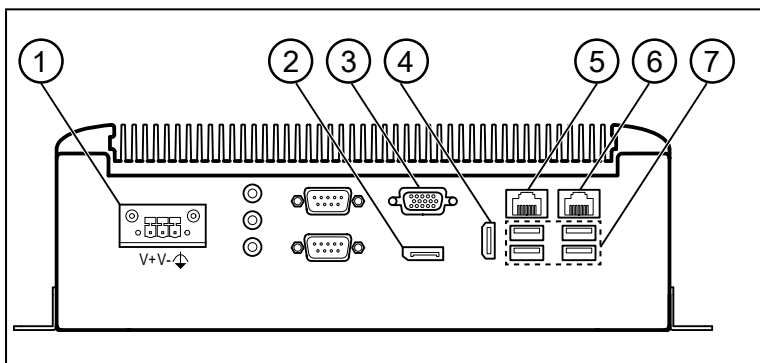

- 1: voltage supply
- 2: display port
- 3: VGA socket
- 4: HDMI interface
- 5: Ethernet interface 2
- 6: Ethernet interface 1
- 7: USB ports

UK

7 Set-up

When the operating voltage has been switched on, the components of the application solution work with the factory settings. The LEDs indicate the status of the devices and interfaces (→ instructions of the individual components).

7.1 Setting up the appliance

The appliance is a pre-configured industrial PC on which the Windows 10 operating system and the software components APA, LR AGENT and LR SMARTOBSERVER are pre-installed.

The appliance has 2 Ethernet interfaces. Interface 1 is used to connect the device to the IoT network. Via interface 2, the user can either access the Windows user interface of the appliance or the LR SMARTOBSERVER via a browser.



Login details for the appliance:

- user: admin
- password: admin

Factory settings of the Ethernet interfaces:

Parameter	Ethernet interface 1	Ethernet interface 2
IP address	192.168.0.50	192.168.2.50
Subnet mask	255.255.255.0	255.255.255.0
Gateway IP address	0.0.0.0	0.0.0.0

There are two options for setting up and operating the appliance (→ 7.1.1; → 7.1.2).

7.1.1 Option 1: local access

The user accesses the user interface of the appliance via an operator terminal on the control cabinet.

- ▶ Connect the monitor to the display port, VGA socket or HDMI interface.
- ▶ Connect the mouse and keyboard to USB ports.
- ▶ Start the appliance.
- > The Windows login screen appears.
- ▶ Enter the login details and confirm with [Enter].
- > The Windows desktop interface of the appliance appears.

7.1.2 Option 2: remote access

The user accesses the user interface of the appliance via a remote desktop connection. For remote access, the Ethernet interfaces of the appliance and the local PC must be configured for the same IP address range.

- ▶ Connect the local PC to Ethernet interface 2 of the appliance.
- ▶ Start the appliance.

On the local PC:

- ▶ [Control Panel] > [Network and Internet] > [Network and Sharing Center]
- ▶ Adapt the Ethernet adapter settings to the IP address range of the appliance's Ethernet interface 2.
- > The local PC can access the Windows user interface of the appliance.
- ▶ Start the Windows app "Remote Desktop Connection".
- ▶ Enter the IP address of Ethernet interface 2 of the appliance and confirm with [Enter].
- > The local PC establishes a connection to the appliance.
- > The Windows login screen appears.
- ▶ Enter the login details and confirm with [Enter].

> The Windows desktop interface of the appliance appears.

7.2 Create a backup copy of the operating system

ifm recommends to create a backup copy of the Windows operating system before continuing to work with the appliance.

Via the appliance:

- ▶ [Control Panel] > [All Control Panel Items] > [Backup and Restore (Windows 7)]
- ▶ Click [Create a system image].
- > A dialogue window appears.
- ▶ Select the destination for the backup copy.
- ▶ Confirm the selection and start the backup.
- > Windows creates a backup copy of the system.



Note on integration into the network:

Windows Defender Antivirus is disabled. It is recommended to activate a firewall and virus protection according to company regulations when the appliance is connected to a network.

These settings may only be made by trained IT personnel.

Recommendation:

1. Activate Windows Firewall for the network card that is connected to the company network:
Control Panel\System and Security\Windows Firewall\Customize Settings

Activate the Windows Firewall (for Private & Public network settings) here ("Turn on Windows Firewall")

2. Activate Windows Defender:

Change the following entry for the Defender in the Windows Registry Editor (regedit):

HKLM:\SOFTWARE\Policies\Microsoft\Windows Defender → "DisableAntiSpyware": Set value from 1 to 0.

(0 = Windows Defender is running and the computer is scanned for spyware. 1 = Windows Defender is switched off and cannot be started.)

7.3 Select a parameter set

Via the appliance:

- ▶ [File Explorer] > [This PC] > [Local Disk (C:)] > [ifm] > [parameter sets]
- ▶ Double-click [eCl@ass VSE100 for AS_Parameter_download_ifm_EN]
- > A spreadsheet program opens.
- ▶ Select the correct parameter set based on the following criteria:
 - equipment
 - type
 - speed category
 - installation
 - industry
- ▶ Copy the selected parameter code (e.g. 36-43-14-03-ftp-BD-01-02-04-0V-1-02-80-011) to the clipboard.

7.4 Start the APA set-up software

- ▶ [Windows Start] > [APA]
- ▶ The APA software opens.

7.5 Configure a new application



On delivery, the VSE100 unit has the following configuration:

IP address 192.168.0.1
Subnet mask 255.255.255.0

The appliance's IP address must be in the same subnet (e.g. 192.168.0.50; this is the preset IP address of the appliance).

- ▶ Click the [+] button in the window [Select application].
- > The window [New application] appears.
- ▶ Click the [Select] button in the [Select file] section.
- ▶ In the folder [This PC] > [Local Disk (C:)] > [ifm] > [parameter sets] > [Pump], search for the parameter code selected under → 7.3, select the corresponding ipar file and click [Open].
- > Application information from the parameter file is displayed in an overview.
- ▶ Check application.
- ▶ If the application is OK, click the [>] button, otherwise open another parameter file.
- > [Select device] appears.
- > The program searches for devices in the network and shows the found devices in a table.
- ▶ Select device and click [>].
- > Connecting to device.
- > The parameters from the parameter file are written to the device.
- > [Done] is displayed when the writing process is finished.
- ▶ Close the window by clicking [✓].

7.6 Display current measured values of the parameters

- ▶ Click [Configuration].
- > The live status and the measured values of the parameters are displayed under [Value] in the table.



Process-related interfering signals may affect vibration diagnostics. If the diagnostic values vary considerably, it is recommended to reduce the monitoring range or the spectrum of the diagnosis objects.

The bearing diagnostic values can also be affected by various factors (such as special plant configurations, start-up and switch-off cycles when running in resonant ranges, process-related factors during operation). If the diagnostic values are heavily affected, a reference movement is recommended for the bearing diagnostics.

7.7 Configure parameters

Depending on the application, limit values may have to be adapted.

- ▶ Click [Configuration].
- ▶ Click [Edit parameters].
- ▶ Enter / set limit values for warning alarm and damage alarm and confirm with [Enter].
- ▶ Click [Write to device].
- > Changed parameter values are active in the device.

8 Operation

8.1 Monitor process data

The LR SMARTOBSERVER enables the monitoring of process data. The LR SMARTOBSERVER is preconfigured for the "pump" application solution.

Access to the LR SMARTOBSERVER via

- remote access via the web interface of the LR SMARTOBSERVER (<http://192.168.2.50:45235/smartobserver>)
- local access (→ 7.1.1 Option 1: local access)
- remote access via remote desktop connection (→ 7.1.2 Option 2: remote access)



Login details for the LR SMARTOBSERVER:

- user name: test
- password: test

- ▶ Start the LR SMARTOBSERVER.
- > The login screen appears.
- ▶ Enter the user name and password and confirm with [OK].
- > The user interface of the LR SMARTOBSERVER appears.

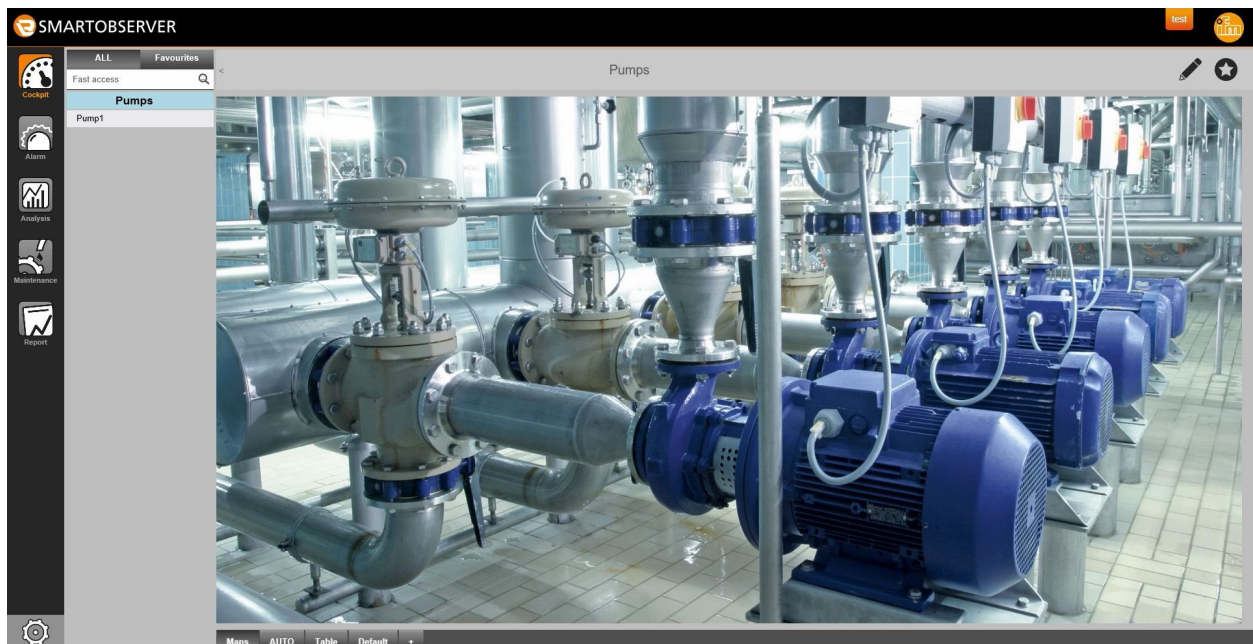

In the [Cockpit] section:

- ▶ Under [Pumps]: Select the application tag of the desired pump (e.g. Pump1).
- ▶ In the status line: Select the [AUTO] tab.
- > The window shows the current process values of the selected pump.

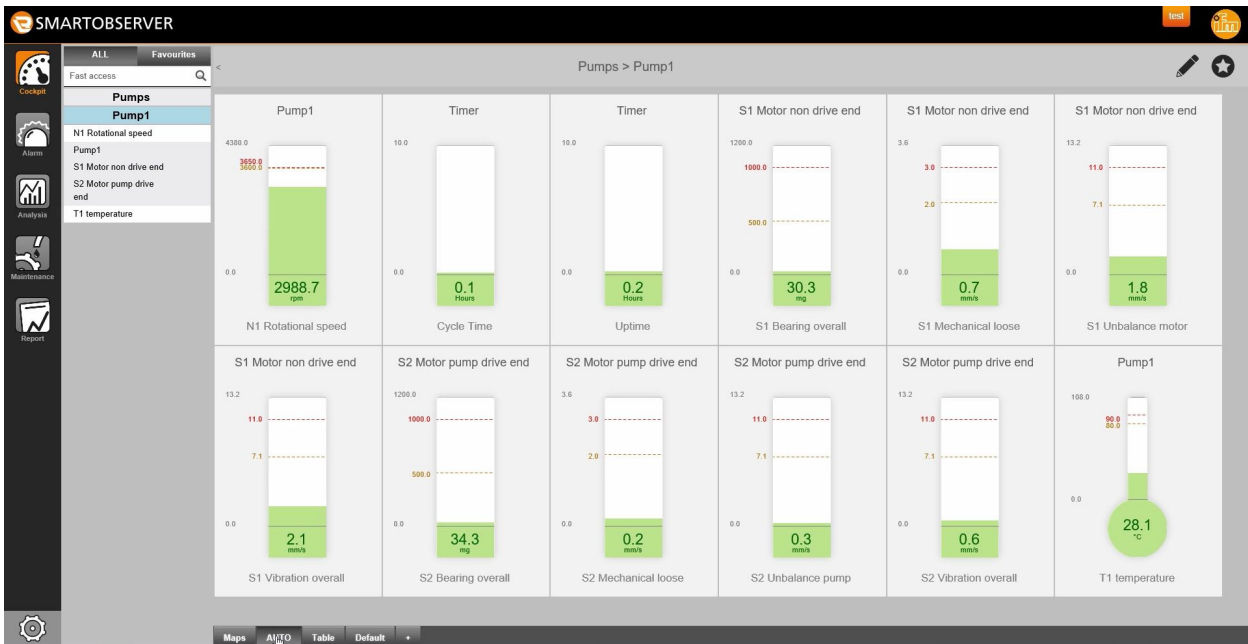







Explanation:

Display	Description	Source
Vibration overall	overall vibration: v-RMS (time domain)	vibration sensor (motor, non drive end / drive end, pump, non drive end / drive end)
Unbalance pump	unbalance	
Bearing overall	bearing monitoring	
Mechanical loose	soft foot, loose fitting	
Dirty blades	unbalance	
Temperature	current motor temperature	temperature sensor
Rotational speed	current speed of the motor in rpm	inductive sensor
Cycle Time	motor runtime	
Uptime	diagnostic unit runtime	diagnostic unit

8.2 Monitoring via the 5-segment light tower

It is also possible to visually signal alarms by means of the 5-segment light tower DV1500 (optional).

-  Segment 1: damage alarm
-  Segment 2: warning alarm
-  Segment 3: operating voltage
-  Segment 4: -
-  Segment 5: -

 For more detailed explanations we refer you to the operating instructions of the 5-segment light tower and to ifm.com.