

Release list Mechanical

for the manufacturing of components
of the Volkswagen Group
„Trade Specific Part“

Release: January 1, 2021
Version: 2.3

Document change history

Version	Date:	Type of Change	Page
2.3	01.01.2021	Changes in contacts	4
		9.3.5.2 Flow monitor: SA5000 as replacement for SI5xxx	7
		9.3.5.3.1 Sensors for the detection of the operating air, design SD Removal of sensors SD6000, SD8000, SD9000, SD2000, SD0523 New addition SD1540	9-10
2.2	01.01.2020	Changes in Contacts	4
		Inclusion of new products 9.3.5.3.1 Type SD – Remark of successor articles SD2500, SD6500, SD8500, SD9500	9
2.1	01.01.2019	Adjustment to cover page and structure of the group template components Editorial work Contacts	All All 4
2.0.1	01.07.2018	Inclusion of new products E30017	17
		Note on further accessories	17
2.0	01.01.2018	Changes in the layout, exchange product pictures	All
		Contacts	4
		9.3.5.1 Position sensing for pneumatic actuators	6
		9.3.5.4.2 Pressure sensor PG – Delete fully electronic contact manometer PG2453	
		9.3.5.4.2 Pressure sensors PNI/PA – New outline numbering	14
		9.3.5.6 Temperature measurement – Delete old appliances TR2432 / TR7432	17
9.3.5.6 New – TM4411	17		

Note:

This document complements the equipment release list Mechanics for the component manufacturing of the Volkswagen Group "Technology-Specific Part".

In particular, VOLKSWAGEN AG reserves all rights for technical exploitation of the information provided in this specifications, including the registration and grant of industrial property rights.

Content changes are shown in grey.

Document edit by: Klaus-Peter Prause, ifm electronic gmbh, D-45128 Essen

Table of contents:

Document change history	2
1 Contact:	4
2 Notes:	5
3 Overview:.....	6
9 Release list mechanical components.....	6
9.3.5 Electrical components.....	6
9.3.5.1 Position sensing for pneumatic actuators	6
9.3.5.2 Flow monitor with integrated amplifier	7
9.3.5.2.3 Flow indicator / Flow meter series SBG	8
9.3.5.3 Flow rate sensors	9
9.3.5.3.1 Flow rate monitor for compressed air, type SD.....	9
9.3.5.3.1 ff Compressed air meter SD1540	10
9.3.5.3.2 Flow rate monitor for water, glycol, oil; type SU.....	11
9.3.5.3.3 Flow rate monitor for conductive liquids, type SM.....	12
9.3.5.4 Electronic pressure monitor	13
9.3.5.4.1 PN - for hydraulic, lubrication, fluids, pneumatics, vacuum.....	13
9.3.5.4.2 PNI + PA.....	14
Application 1: for hydraulic part present monitoring	14
Application 2: for filter monitoring.....	14
9.3.5.5 Level measurement	15
9.3.5.5.1 Capacitive level sensors, type LK	15
9.3.5.5.2 Capacitive level sensors, type LI (Approved to German Federal Water Act (WHG) section 19)	16
9.3.5.6 Temperature Measurement TR / TT plus TM.....	17

1 Contact:

Central contact for VW

ifm electronic gmbh
Vertrieb Deutschland
Daimlerring 6c
D-31135 Hildesheim

Hermann Reinders +49 5121 7667-17
hermann.reinders@ifm.com

Worldwide project management

ifm electronic gmbh
Vertrieb Deutschland
Friedrichstrasse1
D-45128 Essen

Klaus-Peter Prause +49 201 2422-1213
klaus-peter.prause@ifm.com

On-site support in the plants

Audi, plant Ingolstadt

Tilo Haug +49 89 800 91-74
tilo.haug@ifm.com

Audi, plant Győr

Viktória Varga +36 96 518-868
viktoria.varga@ifm.com

Skoda, Werk Mlada Boleslav

Jan Zatloukal +420 73 9410576
Jan.Zatloukal@ifm.com

VW, plants Brunswick, Hannover,
Kassel, Salzgitter, Wolfsburg

Hermann Reinders +49 5121 7667-17
hermann.reinders@ifm.com

VW Sachsen, plant Chemnitz

Jens-Uwe Mücke +49 36601 771-34
jens-uwe.muecke@ifm.com

VW Motor Polska, plant Polkowice

Krzysztof Smaga +48 322705 6400
krzysztof.smaga@ifm.com

2 Notes:

2.1 Purpose of use

The basis for the following release list is the specifications Mechanics for the component productions of the Volkswagen Group in the current issue. The respective requirements and restrictions must be complied with.

2.2 General Notes

General information on the products, such as .B:
Installation instructions, delivery capability, etc.

The devices listed in this release were compiled in cooperation with the plants from the VW Group.

The regulations and execution guidelines used in the higher-level specifications Mechanics must be observed as mandatory!

[Functional accessories is released with.](#)

The use of products other than those listed in this overview must be agreed in advance with the relevant contact persons /coordinators in the plants.

Data sheets and other article information

By clicking with the mouse button on the underlined article number,

E. g. [SD6500](#)

You will get to the respective article on ifm's website and the current information
Such as scale drawings, accessories, operating instructions, etc.

For the EPLAN documentation please visit the [EPLAN DATA PORTAL](#)
or go to the corresponding article on our website.

Here, in the "Downloads" tab you can download the available EPLAN file.

Technical details	Accessories	Downloads	Further information
 EPLAN file			
File	Size	Type	
EPLAN download	74,2 kB	EDZ	

3 Overview:

9 Release list mechanical components

9.3.5 Electrical components

9.3.5.1 Position sensing for pneumatic actuators

Initiator rectangular type of query to pneumatically operated gate valves.



[IN5225](#)

M12 connector, DC PNP, 2 x normally open



[E12517](#)

Ø 53 mm target puck (example)

Click here for further information:

<https://www.ifm.com/de/en/shared/target-pucks-for-dual-sensors>

The target pucks for dual sensors are directly mounted onto the shaft of the quarter-turn actuator. The shaft must conform to VDI/VDE 3845. A round puck with two targets positioned 90° apart in different heights damps the IND dual sensor.

You can find the different target pucks after selection of your actuator manufacturer.

9.3.5.2 Flow monitor with integrated amplifier

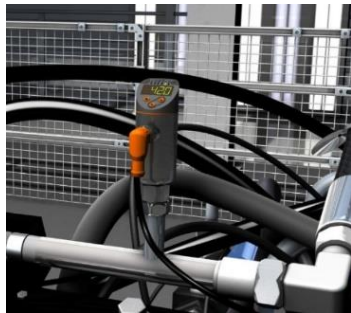





SA5000 - Compact design for adapters
 With integrated media curves for water, oils and air
 Function programmable
 Temperature measuring range: -20...90 °C
 2 digital outputs / 1 analog output / (configurable)
 Plug-in connection M12
 Optimum alignment due to rotability of the process connection

OUT1 Flow rate monitoring (binary / frequency)
 OUT2 Flow rate monitoring (binary / analog / frequenz)
 Temperature monitoring (binary / analog / frequency)

Input: External Teach

ifm article no.	Design	Size [mm]	Application
SA5000		142 x 49,4 x Ø34	100 bar Liquid and gaseous media

Adapter for type SI (selection):

ifm article no.	Design	Size [mm]	Materials
E40096		Adapter G ½ -> M18 x 1.5 - G ½	Stainless steel (1.4404 / 316L)
E40099		Adapter G ¼ -> M18 x 1.5 - G ¼	
E40101		Adapter M12 -> M18 x 1.5 - M12	
E40104		Adapter T-piece -> M18 x 1.5 - L18	

9.3.5.2.3 Flow indicator / Flow meter series SBG

Sensors for the detection of water, glycol-solutions, coolants, oil
(Oil 1 with viscosity 10 mm²/s at 40°C; oil 2 with viscosity 46 mm²/s at 40°C)



Mechatronic flow meter with non-return valve

DC PNP, display (360° rotatable) with LED and indication

OUT1 Normally open / closed programmable or frequency
Flow rate- or temperature-monitoring

OUT2 Normally open / closed programmable or analogue 4...20 mA
Flow rate- or temperature-monitoring



ifm article no.	Design	Size [mm]	Measuring range
<u>SBG234</u>		147 x 113 Process connection: G ½	1...50 l/min -10...100 °C
<u>SBG246</u>		152 x 119 Process connection: G ¾	2...100 l/min -10...100 °C
<u>SBG257</u>		162 x 129 Process connection: G 1 ¼	4...200 l/min -10...100 °C

9.3.5.3 Flow rate sensors

Display of the old equipment removed

9.3.5.3.1 Flow rate monitor for compressed air, type SD

Air Quality (DIN 8573-1:2010): Class 141 and Class 344

Function programmable, temperature display 0...60 °C

Temperature measuring range: -10...60 °C;





Pressure measuring range: -1... 16 bar

2 outputs, plug-in connection M12

OUT1 Flow rate monitoring (binary), quantity counter (pulse),
Preselection counter (binary)
Switching output pressure

OUT2 Flow rate monitoring (binary or analog),
Temperature monitoring, meter reset
Pressure monitoring (binary or analog)

Display: Colour-display 1,44"

ifm article no.	Design	Process Connection	Measuring Range	Display range
SD6500 Successor SD6000		R ½ DN15	0...90 m³/h	0,25...75 m³/h
SD8500 Successor SD8000		R 1 DN25	0...270 m³/h	0,8...225 m³/h
SD9500 Successor SD9000		R 1½ DN40	0...492 m³/h	1,4...410 m³/h
SD2500 Successor SD9000		R 2 DN50	0...840 m³/h	2,5...700 m³/h

9.3.5.3.1 ff Compressed air meter SD1540

Adjustable for inside pipe diameter (14 ... 254 mm)

ifm article no.	Design	Process connection	Measuring Range	Display Range
SD1540 Successor SD0523		G1- lock nut To adapter E40195	0...31520 m ³ /h	0.3...26260 m ³ /h

Accessories for SD0523:

ifm article no.	Design	Process connection	Materials
E40195		Welding adapter Ø 20 mm G 1 I	Stainless steel (1.4404 / 316L)

9.3.5.3.2 Flow rate monitor for water, glycol, oil; type SU

Ultrasonic volumetric flow sensor

Display unit with LED



DC PNP

1 x switching output, normally open / closed programmable

1 x pulse or analogue output

Flow monitoring or temperature monitoring



ifm article no.	Design	Size [mm]	Application
<u>SU7000</u>		96 (110) x 100 x 80.5 Process connection: G $\frac{3}{4}$	Water, glycol, oil Measuring range: 0...50 l/min / -10...80 °C
<u>SU8000</u>		96 (130) x 100 x 80.5 Process connection: G1	Water, glycol, oil Measuring range: 0...100 l/min / -10...80 °C
<u>SU9000</u>		96 (130) x 100 x 80.5 Process connection: G1 $\frac{1}{4}$	Water, glycol, oil Measuring range: 0...200 l/min / -10...80 °C

9.3.5.3.3 Flow rate monitor for conductive liquids, type SM

Magnetic-inductive flow sensor

DC PNP, Display unit with LED

Connector M12



OUT1

Flow monitoring (binary)





Flow rate meter (pulse)

Preset meter (binary)

OUT2

Flow monitoring or temperature monitoring
(analogue or binary)

Input for counter reset

ifm article no.	Design	Size [mm]	Application
<u>SM6000</u>		73 (110) x Ø54 Process connection: G½	Conductive liquids 0.1...25 l/min / -10...70 °C
<u>SM7000</u>		73 (110) x Ø54 Process connection: G¾	Conductive liquids 0.2...50 l/min / -10...70 °C
<u>SM8000</u>		73 (110) x Ø54 Process connection: G1	Conductive liquids 0.2...100 l/min / -10...70 °C
<u>SM9000</u>		113 (200) x Ø116.8 Process connection: G2	Conductive liquids 5...300 l/min / -10...70 °C
<u>SM2000</u>			Conductive liquids 5...600 l/min / -10...70 °C

9.3.5.4 Electronic pressure monitor

9.3.5.4.1 PN - for hydraulic, lubrication, fluids, pneumatics, vacuum



DC PNP
Process connection G $\frac{1}{4}$ I
4-digit alphanumeric Display red / green
Connector M12

PN7 -> 2 x switching outputs, normally open / normally closed programmable

PN3 -> 1 x switching output, normally open / normally closed programmable
1 x analogue output, 4...20 mA or 0...10 V analogue

PN2 -> 1 x switching output, normally open / normally closed programmable
1 x switching output, normally open / normally closed programmable or
1 x analogue output, 4...20 mA or 0...10 V analogue

Programming and concepts according to VDMA-Standard ✓

ifm article no.	Measuring range	Remark	VDMA-Standard	
PN7070	0...400 bar	4-digit Alphanumeric display	✓	
PN7071	0...250 bar		✓	
PN7092	0...100 bar		✓	
PN7094	-1... 10 bar		✓	
PN7099	-1000...1000 mbar		✓	
PN3070	0...400 bar		Alternating indication Of red and green	✓
PN3071	0...250 bar			✓
PN3092	0...100 bar			✓
PN3094	-1... 10 bar			✓
PN2099	-1000...1000 mbar		✓	

[E30420](#)



Protection cover for sensors PN707x/PN709x/PN307x/PN309x/PN209x

9.3.5.4.2 PNI + PA

Application 1: for hydraulic part present monitoring

Part present monitoring via differential pressure measuring

Usage in machine tools with coolants as medium



The combination of PNI and PA detects possible contamination caused by swarf or abrasion.

The machining process is not started before the arising differential pressure is nearly 0 bar.

Note on wiring:

Picture shows usage of T-splitter [E11566](#) and Jumper [EVC010](#).

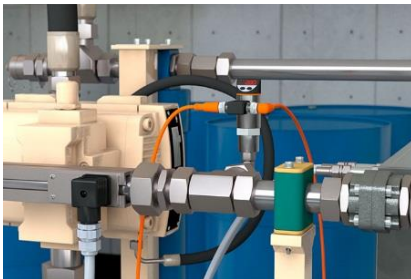

Connection to the control via 8 pole line.

Application 2: for filter monitoring



PNI electronic pressure sensors with an analogue input evaluate the pressure difference in filter elements in combination with PA transmitters.

An increasing pressure difference indicates filter clogging.

ifm article no.	Design	Measuring range	Technical details
PNI024		0...10 bar	4-digit alphanumeric display Input: 0...20 mA / 0...10 V Output: 2 x switching output Normally open / closed programmable Process connection G 1/4 I Connector M12 with 7 poles
PA3024			Analogue output 4...20 mA Process connection G 1/4 I Connector M12 with 4 poles

9.3.5.5 Level measurement

9.3.5.5.1 Capacitive level sensors, type LK



Electronic level sensor
Connector M12
DC PNP

Range:
See notes in the respective data sheets

ifm article no.	Design	Probe Length	Output function / application
LK7022		264 mm	2 operating outputs Normally open / normally closed Programmable Hydrous coolants Mineral oils (dielectric constant < 3) Water, media similar to water
LK7023		472 mm	
LK7024		728 mm	

ifm article no.	Design	Probe Length	Output function / application
LK1022		264 mm	2 operating outputs Normally open / normally closed Programmable Hydrous coolants, oils, water, media similar To water
LK1023		472 mm	
LK1024		728 mm	

ifm article no.	Design	Probe Length	Output function / application
LK8122		264 mm	2 operating outputs (OUT1...OUT3) 1 overflow output (OUT-OP) Indication of the level as a 8-4-2-1 binary code 3 x normally open / closed programmable (OUT1...OUT3); 1 x normally open / closed programmable (OUT-OP) Hydrous coolants, oils, water, Media similar to water
LK8123		472 mm	
LK8124		728 mm	

9.3.5.5.2 Capacitive level sensors, type LI (Approved to German Federal Water Act (WHG) section 19)

Electronic binary level sensor

Connector M12, DC PNP

Range: see notes in the respective data sheets

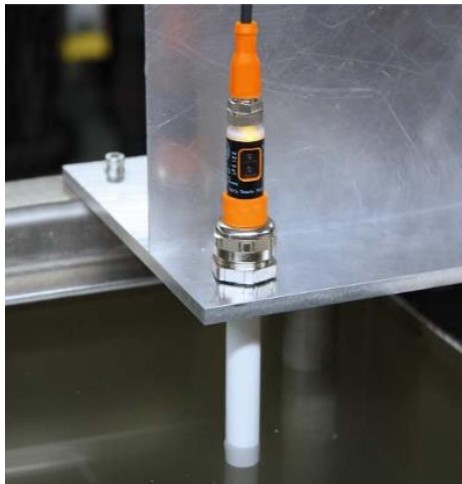

Application: see notes in the respective data sheets

The LI21 series is approved to the German Federal Water Act (WHG) section 19
As overflow protection.

ifm article no.	Design	Probe Length	Output function / application
LI2141		132 mm	1 switching output (normally closed) Hydrous coolants, oils, water, Media similar to Water Overflow protection according to WHG § 19
LI2142		273 mm	
LI2143		481 mm	

9.3.5.6 Temperature Measurement TR / TT plus TM



Temperature sensors for all fluids

DC PNP
Process connection G ½ A
4-digit alphanumeric display
Connector M12



TR - Evaluation unit for temperature sensors

TR7439 2 x switching output, normally open / closed programmable

TR2439 1 x switching output, normally open / closed programmable and
1 x analogue 4...20 mA or 0...10 V (scalable)

ifm article no.	Measuring Range	Remark	Sensors
TR7439	-100...600 °C	4-digit alphanumeric display	PT100/ PT1000 Temperature Sensors
TR2439	Factory setting: 40...300 °C	Alternating Indication of red and green	

Temperature sensor for connection to TRxxxx

ifm article no.	Design	Probe length	Technical details
TT1050	 Ø 10 mm	160 mm	1 x Pt 1000 (To DIN EN 60751, class A) Liquids and gases Measuring range: -40...150° Stainless steel (1.4404 / 316L)
TT2050		260 mm	
TT3050		360 mm	
TT5050		560 mm	
TM4411	 Ø 6 mm	36 mm Minimum Installation Depth: 15 mm	1 x Pt 100 (To DIN EN 60751, class A) Liquids and gases Measuring range: -40...150° Process connection G1/2

Mounting accessories for connection of sensors TT with control monitors TRxxxx

ifm article no.	Design	Remark
E30017		Mounting set Adaption of temperature sensors to control monitors (TT / TR)

Accessories like clamp fitting [E30018](#), several welding adapters, etc. please look <https://www.ifm.com>