



Position sensors

Kplus sensors: One sensing range for all metals



Inductive sensors



Uniform sensing range for the reliable detection of all metals

Compact size for use in the smallest of spaces

Electromagnetic field immune sensor technology to prevent incorrect switching

High-quality stainless steel housing

**IP 65 / IP 69K
for greater reliability**

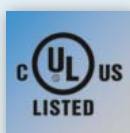
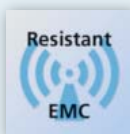
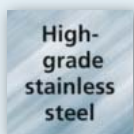
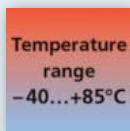
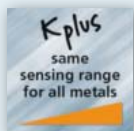

Constant correction factor

Inductive Kplus sensors have the same sensing range for all types of metal. So they are perfectly suited for the detection of aluminium, e.g., where conventional sensors show a considerably reduced sensing range. Moreover, high switching frequencies allow the monitoring of fast-moving targets.

Versatile use

The resistant stainless steel sleeve is also perfectly suited for applications with continuous contact with oils and coolants. The large temperature range as well as the high protection ratings allow universal use of the new sensors. The M8 Kplus sensors are now also available in all common cable versions.



Design	Total length [mm]	Sensing range [mm]	Installation	Output	Output function	Order no.
--------	----------------------	-----------------------	--------------	--------	-----------------	-----------

M8 connector- 3-wire DC

M8	40	3	flush	PNP	normally open	IES200
M8	40	6	non flush	PNP	normally open	IES201

Connection cable 2 m PUR · 3-wire DC

M8	37.5	3	flush	PNP	normally open	IES202
M8	37.5	6	non flush	PNP	normally open	IES203
M8	37.5	3	flush	PNP	normally closed	IES204
M8	37.5	6	non flush	PNP	normally closed	IES205
M8	37.5	3	flush	NPN	normally closed	IES206
M8	37.5	6	non flush	NPN	normally closed	IES207
M8	37.5	3	flush	NPN	normally open	IES208
M8	37.5	6	non flush	NPN	normally open	IES209

Accessories

Design	Description	Order no.
	Angle bracket for type M8, stainless steel	E10734

Connection technology

Design	Description	Order no.
	Socket, M8, 3-pole 2 m black, PUR cable	EVC141
	Socket, M8, 3-pole 5 m black, PUR cable	EVC142

Further technical data

Operating voltage	[V DC]	10...30
Reverse polarity protection		•
Short-circuit protection		•
Overload protection		•
Protection rating		IP 65 / IP 66 / IP 67 / IP 68 / IP 69K
Switching frequency	[Hz]	2000
Protection class		III
Ambient temperature	[°C]	-40...85
Housing materials		high-grade stainless steel (316L), sensing face LCP
Output status indication	[LED]	yellow (4 x 90°)

Wiring diagram

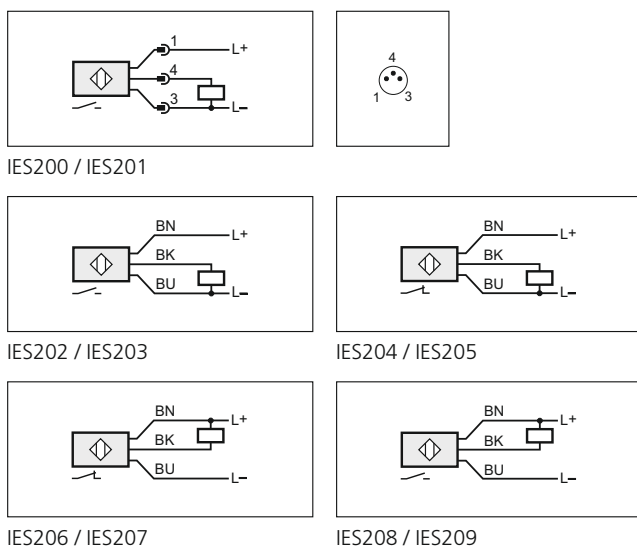

Dimensions

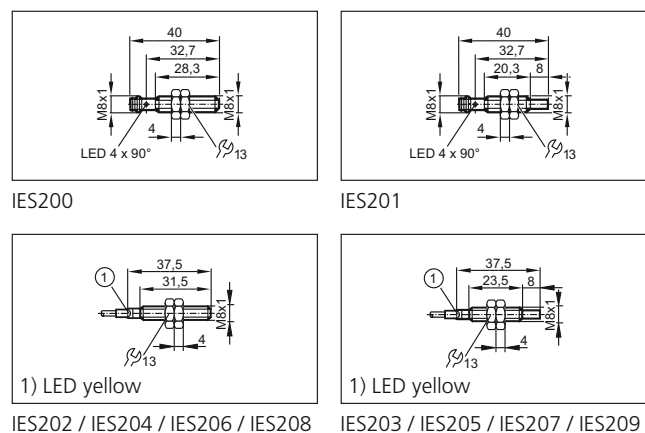

We reserve the right to make technical alterations without prior notice. · 04.2018